

# DFG1E

## FEATURES

- For high speed switching.
- Diffused-junction. Glass passivated and encapsulated.

## OUTLINE DRAWING

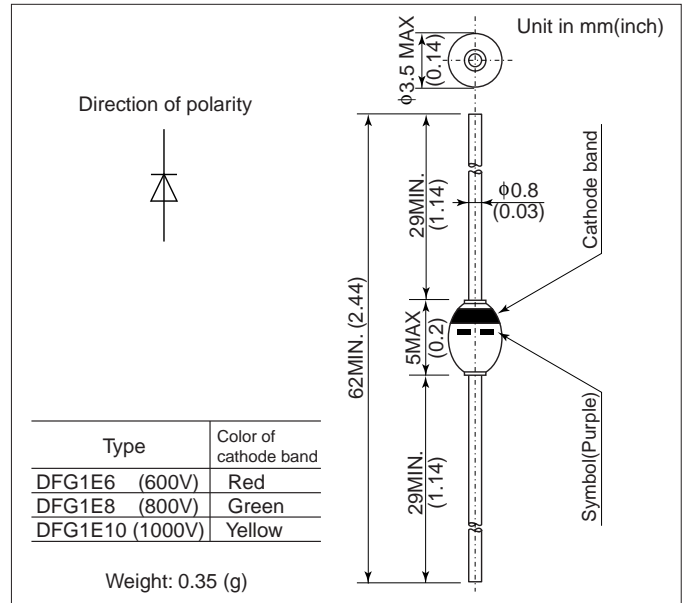

## ABSOLUTE MAXIMUM RATINGS

Items	Type		DFG1E6	DFG1E8	DFG1E10
Repetitive Peak Reverse Voltage	$V_{RRM}$	V	600	800	1000
Average Forward Current	$I_{F(AV)}$	A	0.3 (Single-phase half sine wave 180° conduction ) TL = 100°C, Lead length = 10mm		
Surge(Non-Repetitive) Forward Current	$I_{FSM}$	A	5( Without PIV, 10ms conduction, Tj = 150°C start )		
I <sup>2</sup> t Limit Value	I <sup>2</sup> t	A <sup>2</sup> s	0.1( Time = 2 ~ 10ms, I = RMS value )		
Operating Junction Temperature	T <sub>j</sub>	°C	-65 ~ +150		
Storage Temperature	T <sub>stg</sub>	°C	-65 ~ +150		

- Notes (1) Lead mounting : Lead temperature 300°C max. to 3.2mm from body for 5sec. max..  
 (2) Mechanical strength : Bending 90°×2 cycles or 180°×1 cycle, Tensile 2kg, Twist 90°×1 cycle.

## CHARACTERISTICS(T<sub>L</sub>=25°C)

Items	Symbols	Units	Min.	Typ.	Max.	Test Conditions
Peak Reverse Current	$I_{RRM}$	μA	—	—	10	Rated $V_{RRM}$
Peak Forward Voltage	$V_{FM}$	V	—	—	5.0	$I_{FM}=0.3 A_p$ , Single-phase half sine wave 1 cycle
Reverse Recovery Time	$t_{rr}$	ns	—	—	35	$I_F=0.1A$ , $I_{rp}=0.2A$ , 25% Recovery
Steady State Thermal Impedance	$R_{th(j-a)}$	°C/W	—	—	80	Lead length = 10 mm
	$R_{th(j-l)}$				50	

# DFG1E

## Forward characteristics

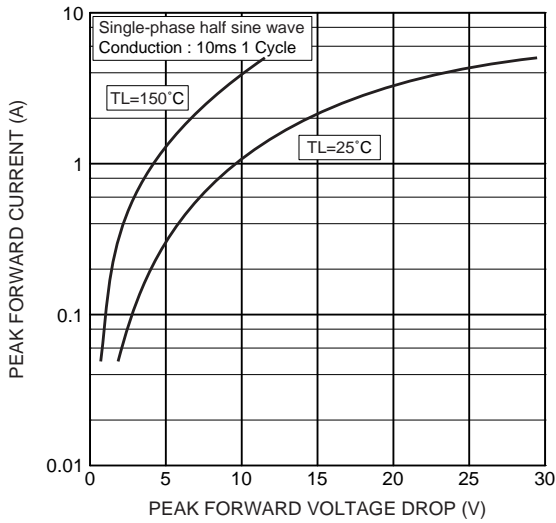

## Max. average forward power dissipation (Resistive or inductive load)

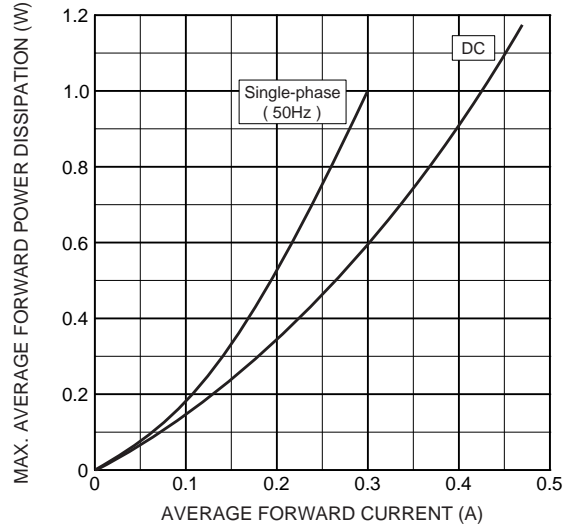

## Max. allowable ambient temperature (Resistive or inductive load)

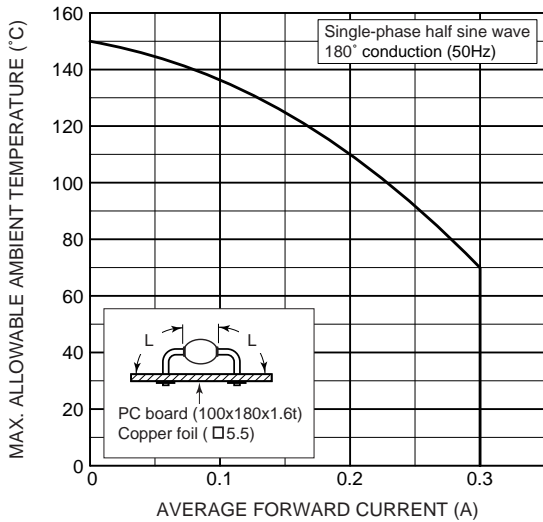

## Max. allowable lead temperature (Resistive or inductive load)

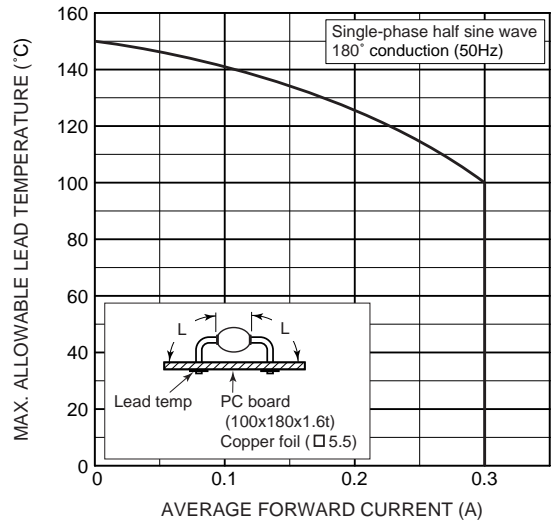

## Surge forward current characteristics (Non-repetitive)

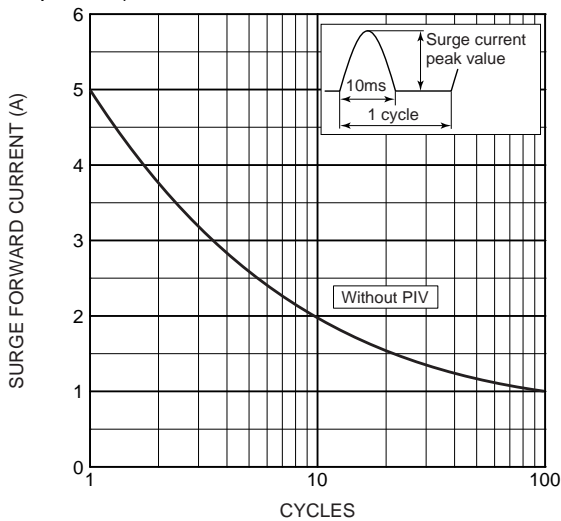

## Steady state thermal impedance

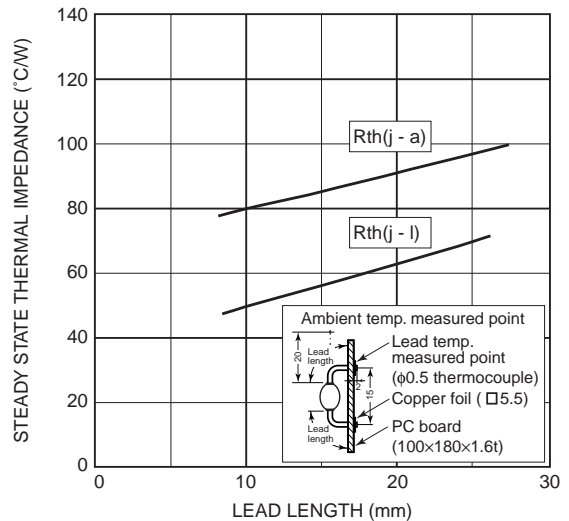

# DFG1E

## Transient thermal impedance

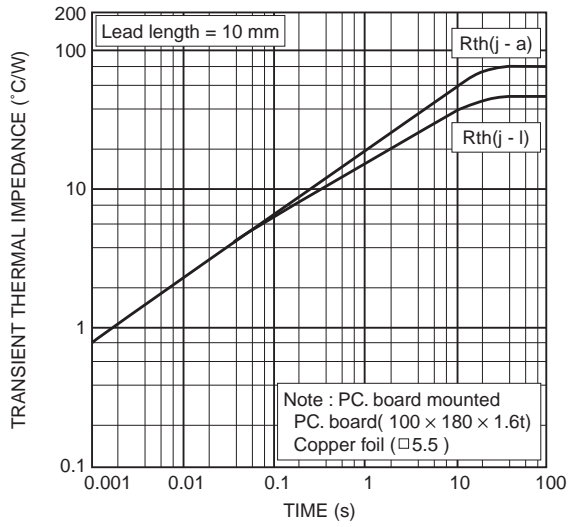

## Reverse recovery time (trr) test circuit

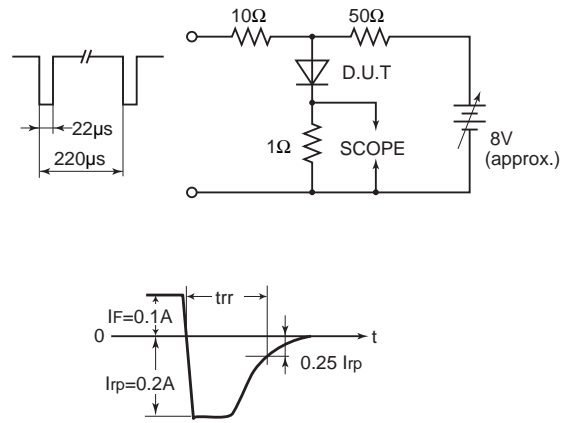

---

## Precautions for Safe Use and Notices

---

If semiconductor devices are handled in inappropriate manner, failures may result.  
For this reason, be sure to read "Precaution for Use" before use.



This mark indicates an item about which caution is required.



### CAUTION

This mark indicates a potentially hazardous situation which, if not avoided, may result in minor or moderate injury and damage to property.



## CAUTION

- (1) Regardless of changes in external conditions during use "absolute maximum ratings" should never be exceed in designing electronic circuits that employ semiconductors. In the case of pulse use, furthermore, "safe operating area(SOA)" precautions should be observed.
- (2) Semiconductor devices may experience failures due to accident or unexpected surge voltages. Accordingly, adopt safe design features, such as redundancy or prevention of erroneous action, to avoid extensive damage in the event of a failure.
- (3) In cases where extremely high reliability is required (such as use in nuclear power control, aerospace and aviation, traffic equipment, life-support-related medical equipment, fuel control equipment and various kinds of safety equipment), safety should be ensured by using semiconductor devices that feature assured safety or by means of user's fail-safe precautions or other arrangement. Or consult Hitachi's sales department staff.

(If a semiconductor device fails, there may be cases in which the semiconductor device, wiring or wiring pattern will emit smoke or cause a fire or in which the semiconductor device will burst)

---

## NOTICES

---

1. This Datasheet contains the specifications, characteristics(in figures and tables), dimensions and handling notes concerning power semiconductor products (hereinafter called "products") to aid in the selection of suitable products.
2. The specifications and dimensions, etc. stated in this Datasheet are subject to change without prior notice to improve products characteristics. Before ordering, purchasers are advised to contact Hitachi's sales department for the latest version of this Datasheet and specifications.
3. In no event shall Hitachi be liable for any damage that may result from an accident or any other cause during operation of the user's units according to this Datasheet. Hitachi assumes to responsibility for any intellectual property claims or any other problems that may result from applications of information, products or circuits described in this Datasheet.
4. In no event shall Hitachi be liable for any failure in a semiconductor device or any secondary damage resulting from use at a value exceeding the absolute maximum rating.
5. No license is granted by this Datasheet under any patents or other rights of any third party or Hitachi Power Semiconductor Device, Ltd.
6. This Datasheet may not be reproduced or duplicated, in any form, in whole or in part, without the expressed written permission of Hitachi Power Semiconductor Device, Ltd.
7. The products (technologies) described in this Datasheet are not to be provided to any party whose purpose in their application will hinder maintenance of international peace and safety nor are they to be applied to that purpose by their direct purchasers or any third party. When exporting these products (technologies), the necessary procedures are to be taken in accordance with related laws and regulations.

Refer to the following website for the latest information. Consult Hitachi's sales department staff if you have any questions.

<http://www.hitachi-power-semiconductor-device.co.jp/en/>