

MBN1500E33E3

Silicon N-channel IGBT 3300V E3 version

FEATURES

- * Soft switching behavior & low conduction loss:
Soft low-injection punch-through High conductivity IGBT.
- * Low driving power due to low input capacitance MOS gate.
- * Low noise recovery: Ultra soft fast recovery diode.
- * High thermal fatigue durability:
($\Delta T_c=70K$, $N>30,000$ cycles)
AlSiC base-plate/AlN substrate

ABSOLUTE MAXIMUM RATINGS (T_C=25°C)

Item	Symbol	Unit	MBN1500E33E3
Collector Emitter Voltage	V _{CES}	V	3,300
Gate Emitter Voltage	V _{GES}	V	±20
Collector Current	DC	I _C	1,500 (T _C =95°C)
	1ms	I _{Cp}	3,000
Forward Current	DC	I _F	1,500
	1ms	I _{FM}	3,000
Junction Temperature	T _J	°C	-40 ~ +150
Storage Temperature	T _{stg}	°C	-50 ~ +125
Isolation Voltage	V _{ISO}	V _{RMS}	6,000(AC 1 minute)
Screw Torque	Terminals (M4/M8)	-	2/15 (1)
	Mounting (M6)	-	6 (2)

Notes: (1) Recommended Value $1.8 \pm 0.2/15^{+0.3} N \cdot m$

(2) Recommended Value $5.5 \pm 0.5 N \cdot m$

ELECTRICAL CHARACTERISTICS

Item	Symbol	Unit	Min.	Typ.	Max.	Test Conditions
Collector Emitter Cut-Off Current	I _{CES}	mA	-	-	12	V _{CE} =3,300V, V _{GE} =0V, T _J =25°C
Gate Emitter Leakage Current	I _{GES}	nA	-500	-	+500	V _{GE} =±20V, V _{CE} =0V, T _J =25°C
Collector Emitter Saturation Voltage	V _{CE(sat)}	V	-	2.45	-	I _C =1,500A, V _{GE} =15V, T _J =25°C
			2.80	3.20	3.80	I _C =1,500A, V _{GE} =15V, T _J =125°C
			-	3.60	-	I _C =1,500A, V _{GE} =15V, T _J =150°C
Gate Emitter Threshold Voltage	V _{GE(TO)}	V	5.5	6.3	7.5	V _{CE} =10V, I _C =1,500mA, T _J =25°C
Input Capacitance	C _{ies}	nF	-	195	-	V _{CE} =10V, V _{GE} =0V, f=100kHz, T _J =25°C
Internal Gate Resistance	R _{ge}	Ω	-	0.9	-	V _{CE} =10V, V _{GE} =0V, f=100kHz, T _J =25°C
Switching Times	Rise Time	t _r	1.6	2.1	2.8	V _{CC} =1,650V, I _C =1,500A
	Turn On Time	t _{on}	2.1	3.2	4.0	L=100nH
	Fall Time	t _f	1.1	2.1	3.3	R _G =2.7Ω/2.7Ω, C _{GE} =330nF (3)
	Turn Off Time	t _{off}	2.8	4.6	5.8	V _{GE} =±15V, T _J =125°C
Peak Forward Voltage Drop	V _{FM}	V	-	2.50	-	I _F =1,500A, V _{GE} =0V, T _J =25°C
			2.20	2.70	3.20	I _F =1,500A, V _{GE} =0V, T _J =125°C
			-	2.60	-	I _F =1,500A, V _{GE} =0V, T _J =150°C
Reverse Recovery Time	t _{rr}	μs	-	0.9	1.4	V _{CC} =1,650V, I _F =1,500A, L=100nH T _J =125°C
Short Circuit Pulse Width	t _{sc}	μs	10	-	-	V _{CC} =2000V, L _s =120nH R _G (on/off)=2.7/27Ω, V _{GE} =±15V, T _J =125°C
Turn On Loss	E _{on(10%)}	J/P	-	3.2	3.7	T _J =125°C
	E _{on(full)}		-	3.5	-	T _J =150°C
Turn Off Loss	E _{off(10%)}	J/P	-	2.1	2.8	T _J =125°C
	E _{off(full)}		-	2.65	-	T _J =150°C
			-	2.74	-	T _J =150°C
Reverse Recovery Loss	E _{rr(10%)}	J/P	-	1.5	2.0	T _J =125°C
	E _{rr(full)}		-	2.0	-	T _J =125°C
			-	2.5	-	T _J =150°C

Notes:(3) R_G and C_{GE} value are the test condition's value for evaluation of the switching times, not recommended value.

Please, determine the suitable R_G value after the measurement of switching waveforms (overshoot voltage, etc.) with appliance mounted.

* Please contact our representatives at order.

* For improvement, specifications are subject to change without notice.

* For actual application, please confirm this spec sheet is the newest revision.

MBN1500E33E3

THERMAL CHARACTERISTICS

Item	Symbol	Unit	Min.	Typ.	Max.	Conditions
Thermal Impedance	IGBT	$R_{th(j-c)}$	-	-	0.0078	Junction to case
	FWD	$R_{th(j-c)}$	-	-	0.0156	
Contact Thermal Impedance	$R_{th(c-f)}$	K/W	-	0.005	-	Case to fin ($\lambda_{grease}=1W/(m \cdot K)$, heat-sink flatness $\leq 50\mu m$)

DEFINITION OF TEST CIRCUIT

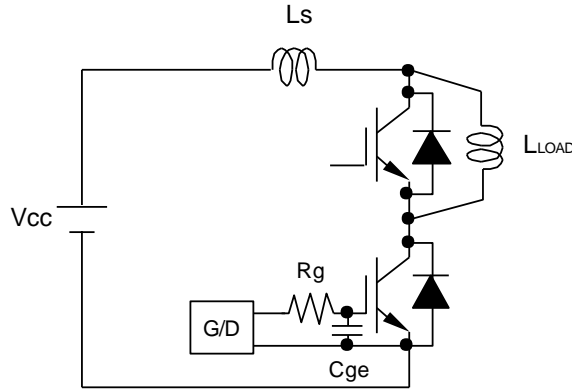

Fig.1 Switching test circuit

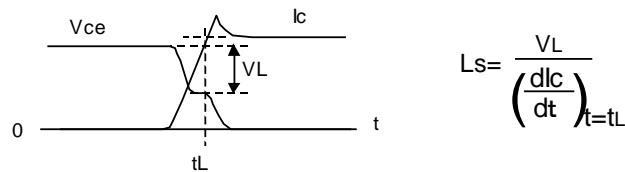

Fig.2 Definition of stray inductance

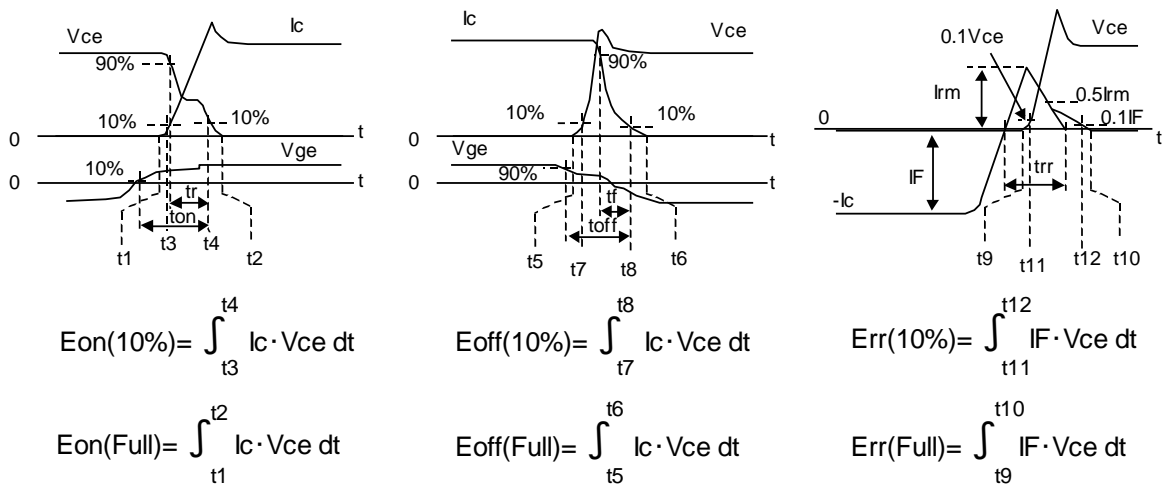
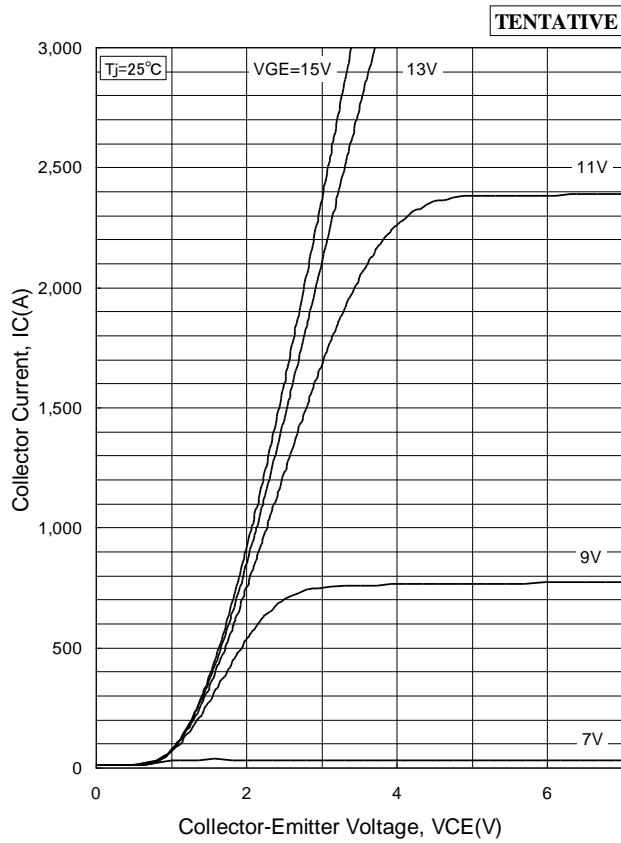

Fig.3 Definition of switching loss

MBN1500E33E3

STATIC CHARACTERISTICS



Collector Current vs. Collector to Emmitter Voltage

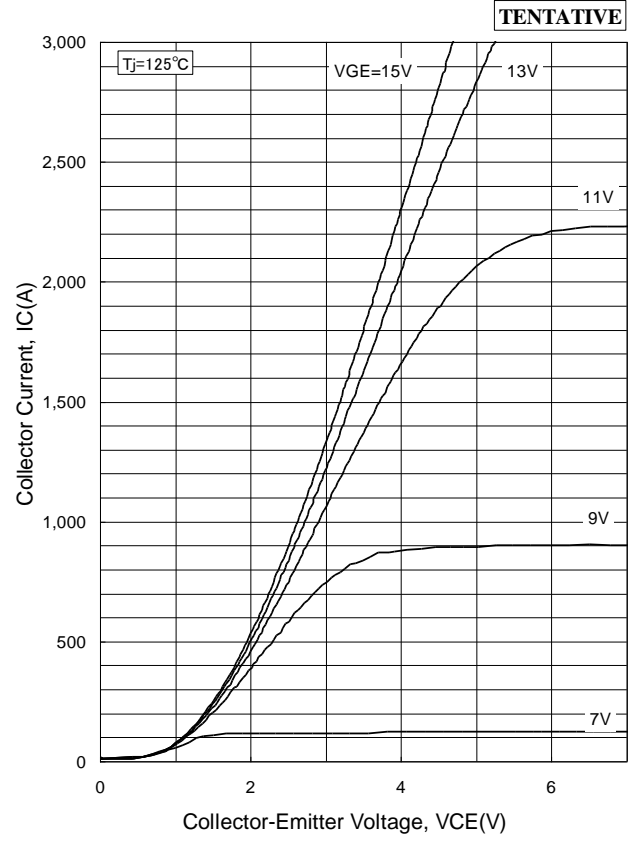

Collector Current vs. Collector to Emmitter Voltage

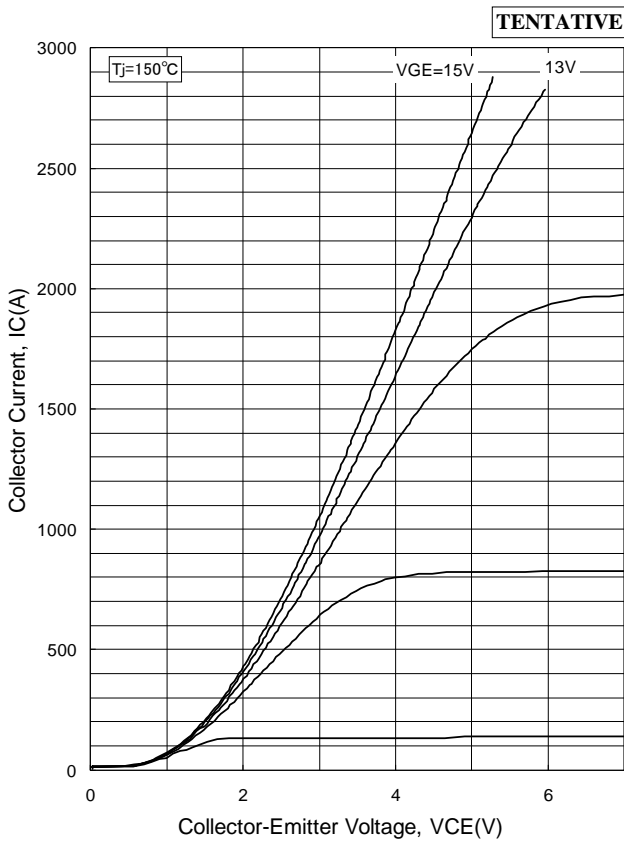

Collector Current vs. Collector to Emmitter Voltage

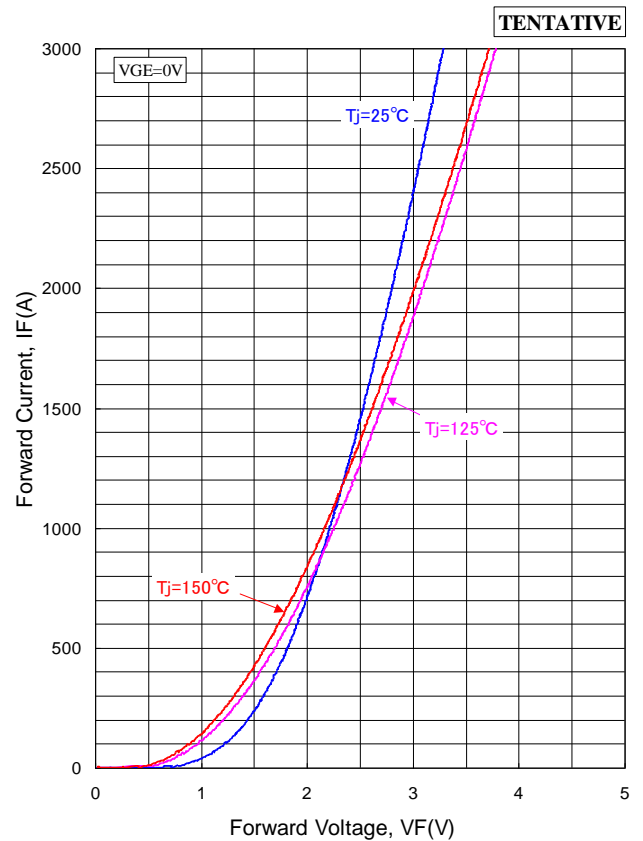

Forward Voltage of free-wheeling diode

MBN1500E33E3

DYNAMIC CHARACTERISTICS

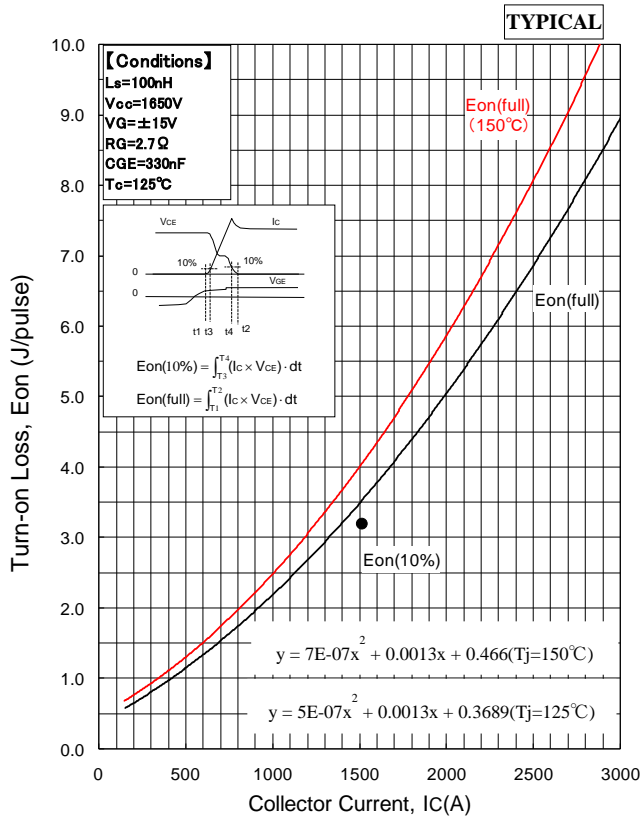

Turn-on Loss vs. Collector Current

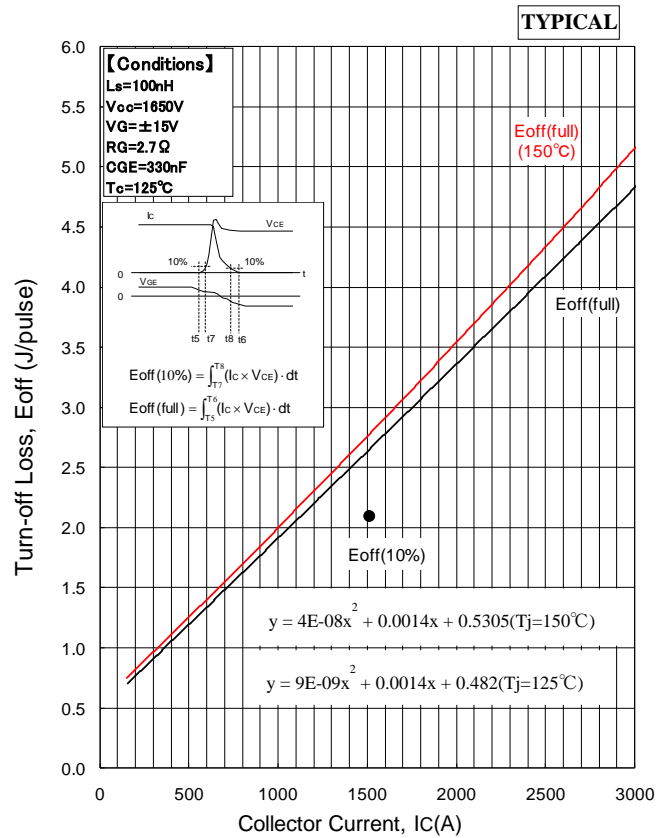

Turn-off Loss vs. Collector Current

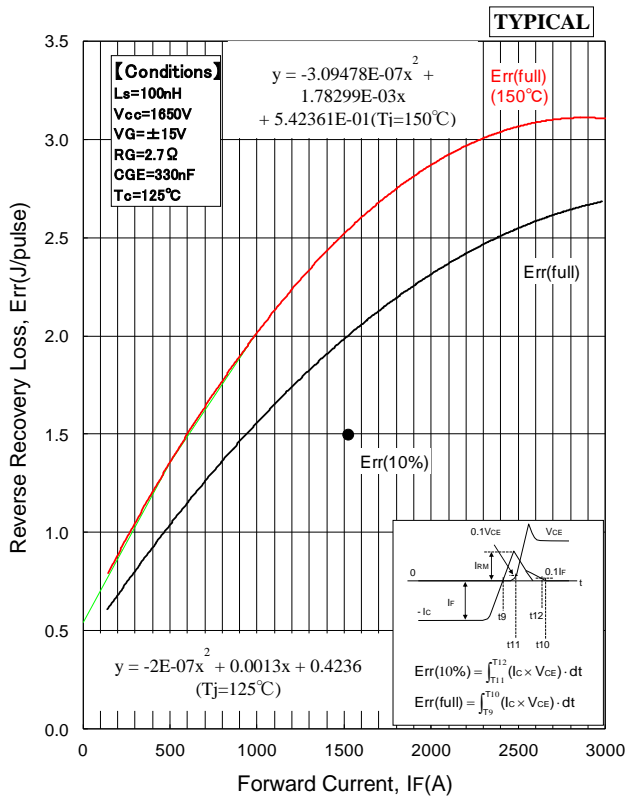

Recovery Loss vs. Forward Current

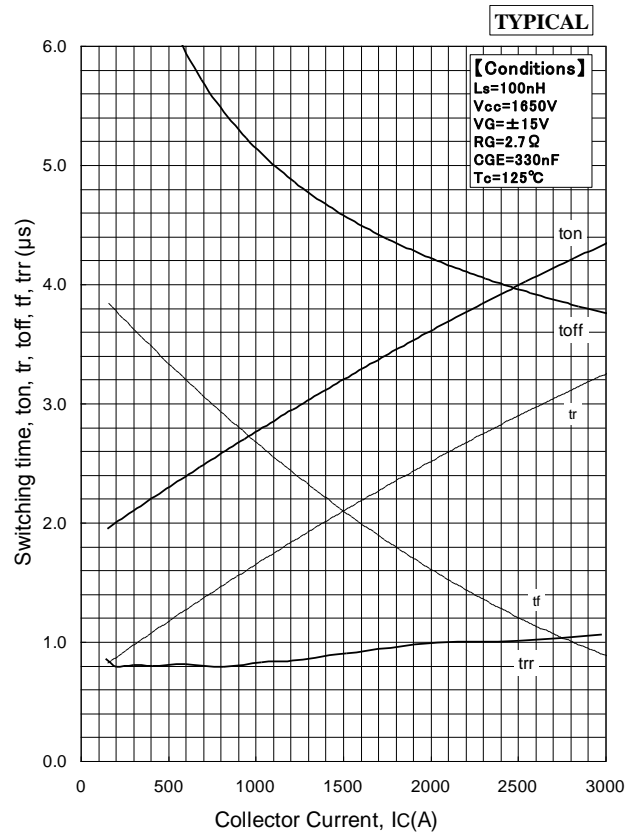

Switching time vs. Collector current

MBN1500E33E3

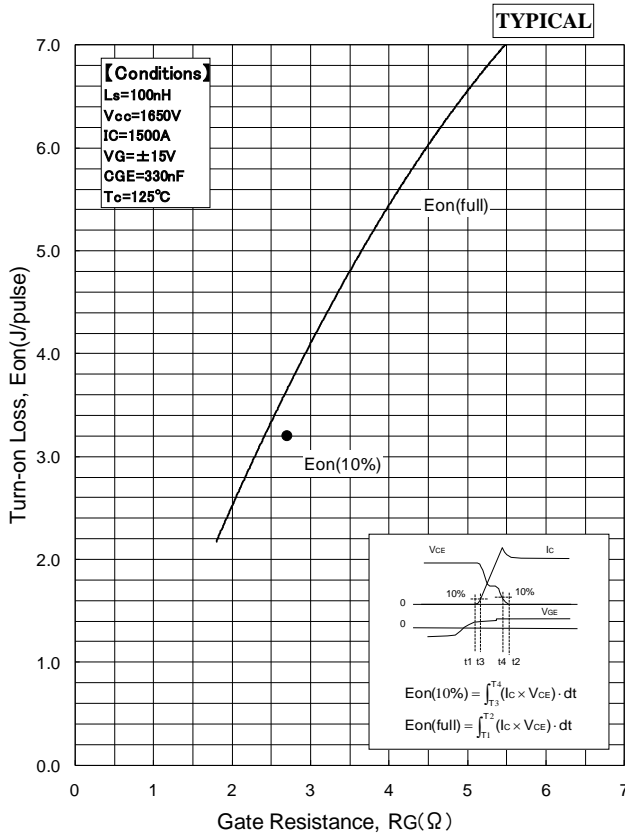

Turn-on Loss vs. Gate Resistance

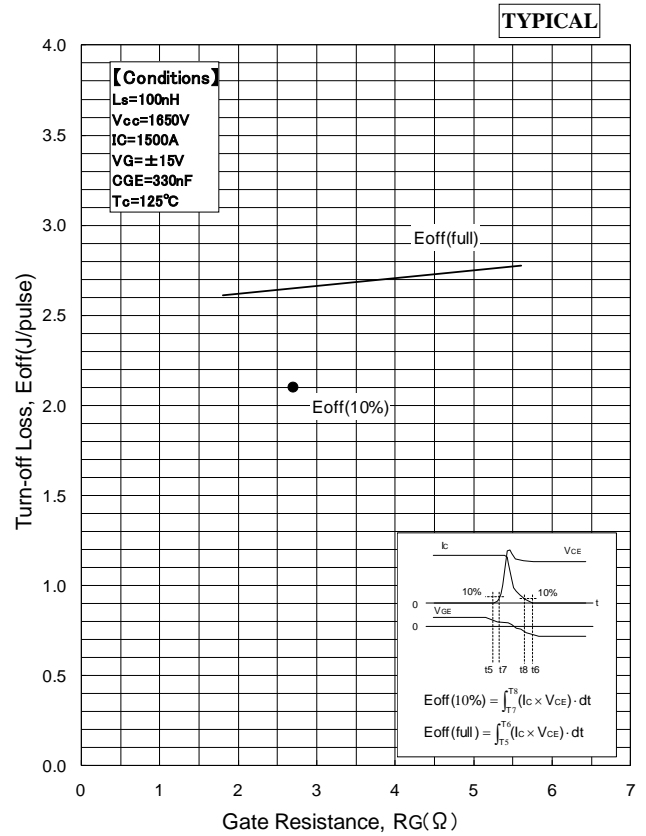

Turn-off Loss vs. Gate Resistance

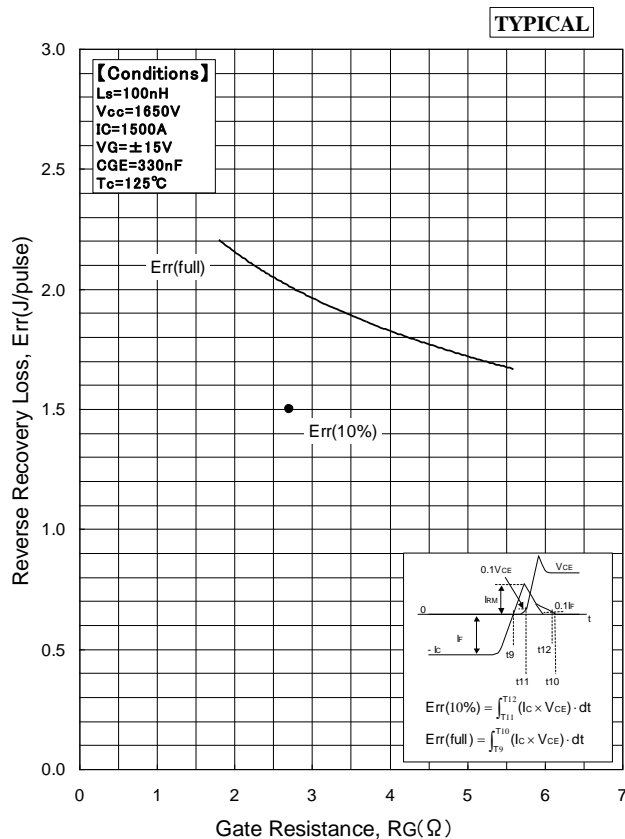

Recovery Loss vs. Gate Resistance

MBN1500E33E3

OUTLINE DRAWINGS

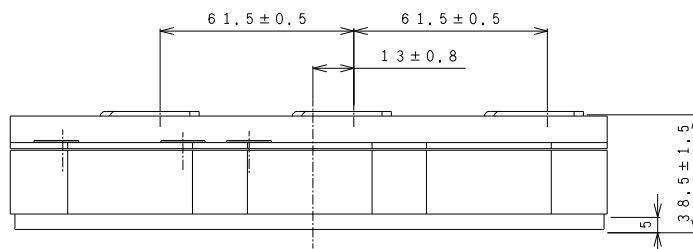
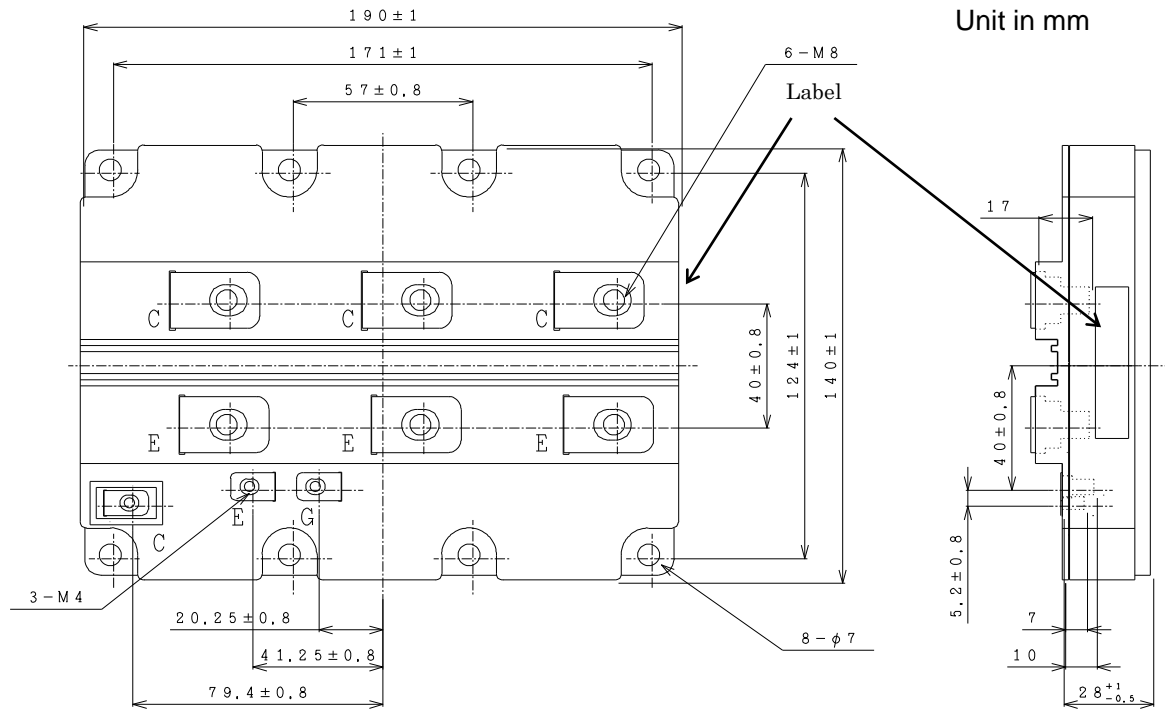

Weight: 1300(g)

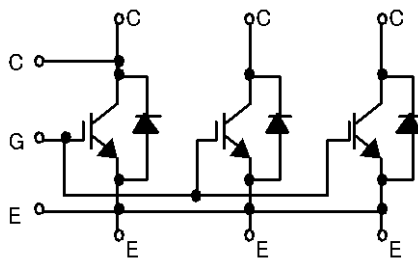

Circuit diagram

MBN1500E33E3

TRANSIENT THERMAL IMPEDANCE

Maximum

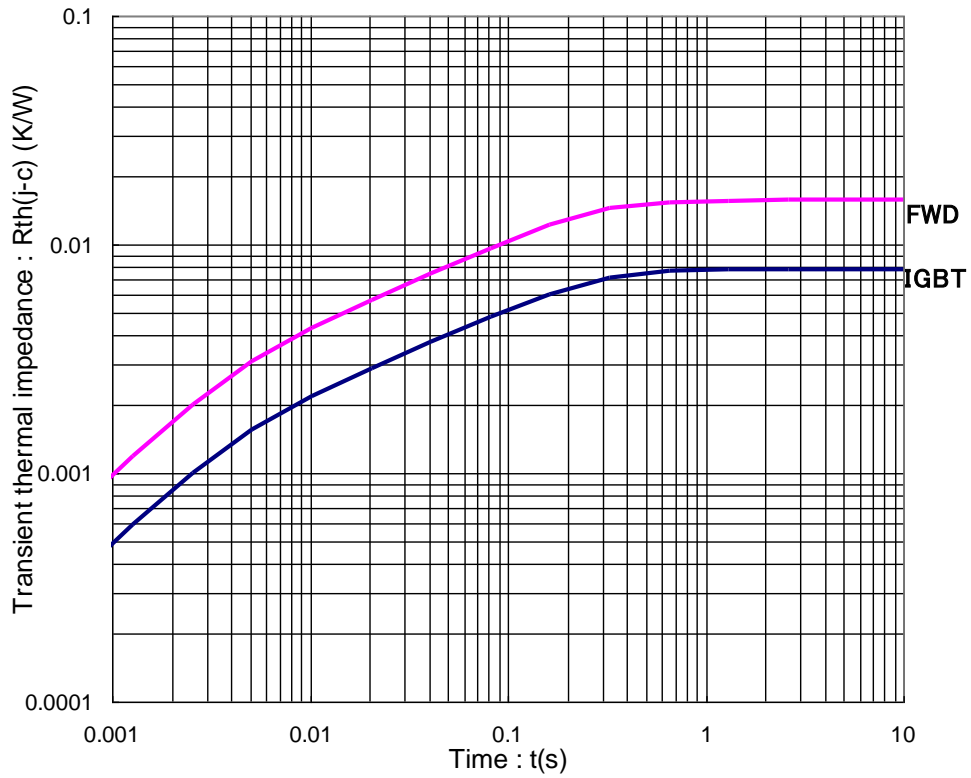

Transient Thermal Impedance Curve

Curve approximation model

$$Z_{th} = \sum r_{th}[n] * (1 - \exp(-t/r_{th}[n]))$$

n	1	2	3	4	Unit
$\tau_{th}[n]$	1.60E-01	2.77E-02	4.10E-03	8.06E-04	sec
$r_{th}[n,IGBT]$	4.84E-03	1.41E-03	1.39E-03	1.63E-04	K/W
$r_{th}[n,Diode]$	9.62E-03	2.94E-03	2.70E-03	3.38E-04	K/W

MBN1500E33E3

QG-VG CURVE

TYPICAL

Conditions: $L_s=100\text{nH}$, $V_{CC}=1650\text{V}$, $I_C=1500\text{A}$,
 $V_{GE}=\pm 15\text{V}$, $T_j=25^\circ\text{C}$

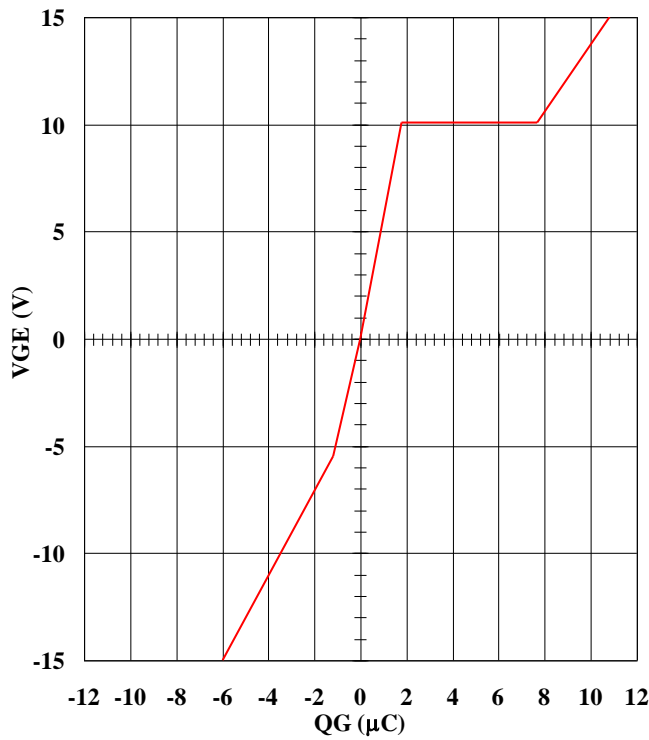

QG-VGE curve

Material declaration

Please note the following materials are contained in the product, in order to keep characteristic and reliability level.

Material	Contained part
Lead (Pb) and its compounds	Solder

MBN1500E33E3

RBSOA

Conditions: $V_{cc} \leq 2200V$, $I_c \leq 3000A$,
 $R_g \geq 2.7\Omega$, $C_{GE} \geq 330nF$
 $V_{GE} = \pm 15V$, $-40^\circ C \leq T_j \leq 150^\circ C$,
 $L_s \leq 100nH$, on pulse width $\geq 10\mu s$
 (Vce spike voltage and L_s are defined at auxiliary terminal)

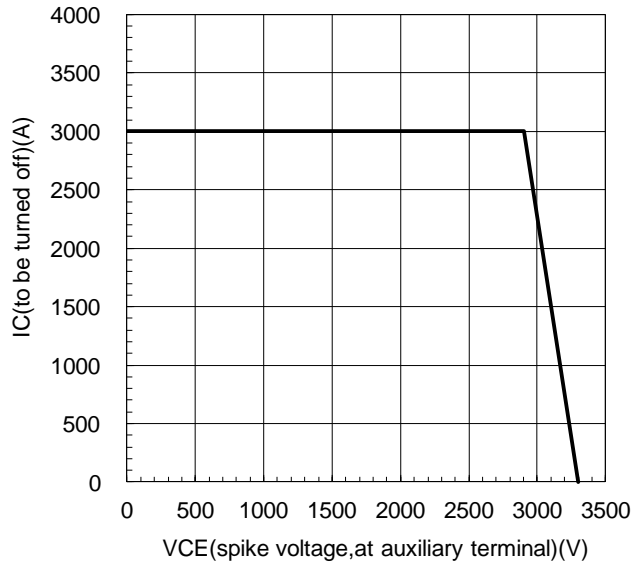
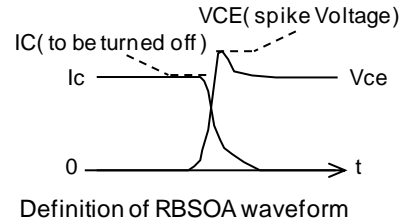

Reverse bias safe operation area (RBSOA)

RecSOA

Conditions: $V_{cc} \leq 2000V$, $di/dt \leq 6,400A/\mu s$,
 $T_j = 150^\circ C$, $L_s \leq 100nH$

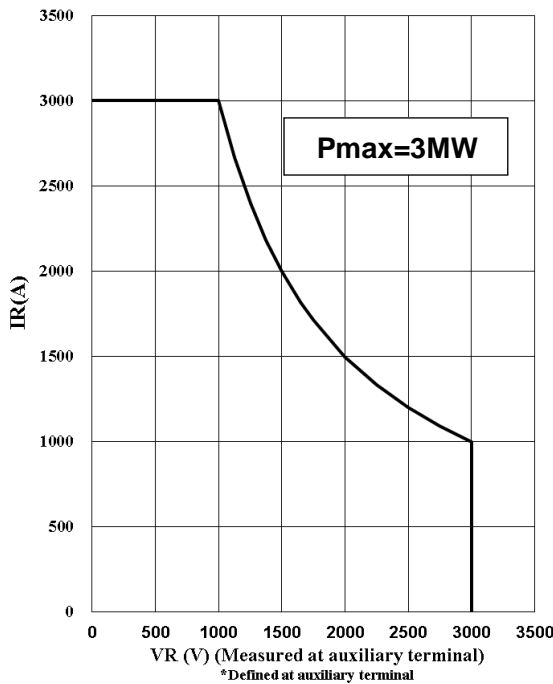

Reverse recovery operation area(RecSOA)

MBN1500E33E3

HITACHI POWER SEMICONDUCTORS

Notices

1. The information given herein, including the specifications and dimensions, is subject to change without prior notice to improve product characteristics. Before ordering, purchasers are advised to contact Hitachi sales department for the latest version of this data sheets.
2. Please be sure to read "Precautions for Safe Use and Notices" in the individual brochure before use.
3. In cases where extremely high reliability is required (such as use in nuclear power control, aerospace and aviation, traffic equipment, life-support-related medical equipment, fuel control equipment and various kinds of safety equipment), safety should be ensured by using semiconductor devices that feature assured safety or by means of users' fail-safe precautions or other arrangement. Or consult Hitachi's sales department staff.
4. In no event shall Hitachi be liable for any damages that may result from an accident or any other cause during operation of the user's units according to this data sheets. Hitachi assumes no responsibility for any intellectual property claims or any other problems that may result from applications of information, products or circuits described in this data sheets.
5. In no event shall Hitachi be liable for any failure in a semiconductor device or any secondary damage resulting from use at a value exceeding the absolute maximum rating.
6. No license is granted by this data sheets under any patents or other rights of any third party or Hitachi, Ltd.
7. This data sheets may not be reproduced or duplicated, in any form, in whole or in part, without the expressed written permission of Hitachi, Ltd.
8. The products (technologies) described in this data sheets are not to be provided to any party whose purpose in their application will hinder maintenance of international peace and safety not are they to be applied to that purpose by their direct purchasers or any third party. When exporting these products (technologies), the necessary procedures are to be taken in accordance with related laws and regulations.

-
- For inquiries relating to the products, please contact nearest overseas representatives that is located "Inquiry" portion on the top page of a home page.
-

Hitachi power semiconductor home page address <http://www.hitachi.co.jp/products/power/pse/>