

Hitachi Power Diodes

Status List

Date: Jul. 2021

Compliance status of RoHS directive

C:Compliant S.C:Compliant (Included RoHS exemption substance) N:Non compliant

Production Status

M:Mass production O:Order production U:Under development
 W:Working sample N:Not recommend for new design D:Discontinued
 E:Engineering sample

Load Dump Surge Suppressor Diodes

Type	Absolute maximum ratings			Characteristics			Outline	RoHS Status	Production year	Production status				
	PRSM (kW)	Vdc (V)	Tj (°C)	Vz (V)		Test Current (mA)								
				Min.	Max.									
ZSH5MA27(※)	3.0kW 62A	18	-40 ~+150	24.0	30.0	10	6A	S.C	2000	M				
ZSH5MA27(A)(※)										N				
ZSH5MA27(S)(※)										M				
ZSH5MC27(※)	3.2kW 65A	18						24.0	30.0	10	6A	S.C	2007	M
ZSH5MC27(S)(※)														M
ZSH5MAZ27	3.4kW 70A	22						24.0	30.0	10	8	S.C	2009	M
ZSH5ME27				M										
ZSH8MD27	5.7kW 130A	32		36.0	44.0	10	6B	S.C	2015	M				
ZSH8MD40	5.7kW 80A									M				
ZSH5MT27C	3.4kW 70A	22		24.0	30.0	10	7A	S.C	2009	M				
ZSH5MT27(Z)	4.3kW 90A									O				
ZSH5MT40C	4.3kW 62A	32		36.0	44.0	10				M				
ZSH5MT48C	4.3kW 50A	39		43.2	52.8	10				M				
ZSH5MT53C	4.3kW 45A	43		47.7	58.3	10				O				
ZSH5MV14	4.3kW 200A	11	13.0	15.0	10	5				S.C	2013	M		
ZSH5MV27	4.3kW 100A	22	24.0	30.0	10		2012	M						

※ Please consider alternative new products as follows.

ZSH5MA27/27(A)/27(S) --> ZSH5MAZ27,ZSH5MT series,ZSH8MD27
 ZSH5MC27/27(S) --> ZSH5MAZ27,ZSH5MT series,ZSH8MD27

Surge Suppressor Diodes

◆ Surface Mount Type

Type	Absolute maximum ratings			Characteristics			Outline	RoHS Status	Production year	Production status	
	PRSM (kW)	VRM (V)	Tj (°C)	Vz (V)		Test Current (mA)					
				Min.	Max.						
DAM1MB	0.6	-65 ~+185	12	9.7	11.4	12.7	1	4A	S.C	2013	M
			13	10.5	12.4	14.1	1				M
			15	12.1	13.5	15.6	1				M
			16	12.9	15.3	17.1	1				M
			18	14.5	16.8	19.1	1				M
			20	16.2	18.8	21.2	1				O
			22	17.8	20.8	23.3	1				M
			24	19.4	22.7	25.6	1				M
			27	21.8	25.1	28.9	1				M
			30	24.3	28.0	32.0	1				M
			33	26.8	31.0	35.0	1				M
			36	29.1	33.4	38.6	1				M
			39	31.6	36.1	41.9	1				M
			43	34.8	39.8	46.2	1				O
			47	38.0	43.3	50.7	1				M
			51	41.3	46.9	55.1	1				M
68	55.1	61.2	74.8	1	M						
75	60.7	67.5	82.5	1	M						
82	66.4	73.8	90.2	1	O						
DAM2MB	1.2	-65 ~+185	12	9.7	11.4	12.7	1	4B	S.C	2013	O
			13	10.5	12.4	14.1	1				O
			15	12.1	13.5	15.6	1				O
			16	12.9	15.3	17.1	1				O
			18	14.5	16.8	19.1	1				O
			20	16.2	18.8	21.2	1				O
			22	17.8	20.8	23.3	1				O
			24	19.4	22.7	25.6	1				O
			27	21.8	25.1	28.9	1				M
			30	24.3	28.0	32.0	1				M
			33	26.8	31.0	35.0	1				M
			36	29.1	33.4	38.6	1				M
			39	31.6	36.1	41.9	1				M
			43	34.8	39.8	46.2	1				O
			47	38.0	43.3	50.7	1				M
			51	41.3	46.9	55.1	1				O
68	55.1	61.2	74.8	1	O						
75	60.7	67.5	82.5	1	O						
82	66.4	73.8	90.2	1	O						
DAM3MB	1.8	-65 ~+185	12	9.7	11.4	12.7	1	4C	S.C	2013	M
			13	10.5	12.4	14.1	1				M
			15	12.1	13.5	15.6	1				M
			16	12.9	15.3	17.1	1				M
			18	14.5	16.8	19.1	1				O
			20	16.2	18.8	21.2	1				M
			22	17.8	20.8	23.3	1				O
			24	19.4	22.7	25.6	1				O
			27	21.8	25.1	28.9	1				M
			30	24.3	28.0	32.0	1				M
			33	26.8	31.0	35.0	1				M
			36	29.1	33.4	38.6	1				M
			39	31.6	36.1	41.9	1				M
			43	34.8	39.8	46.2	1				O
			47	38.0	43.3	50.7	1				M
			51	41.3	46.9	55.1	1				M
68	55.1	61.2	74.8	1	M						
75	60.7	67.5	82.5	1	O						
82	66.4	73.8	90.2	1	M						

Fast Recovery Diodes

◆Surface Mount Type

Type	Absolute maximum ratings				Characteristics		Outline	RoHS Status	Production year	Production status
	V _{RRM} (V)	I _{F(AV)} (A)	I _{FSM} (A)	T _j (°C)	V _{FM} (at I _{FM}) (V) (A)	t _{rr} (ns)				
DFM1MF2	200	1.0	25	-40 ~ +150	0.95 (1.0)	35	4A	S.C	1997	M
DFM3MF2	200	3.0	50	-40 ~ +150	0.95 (3.0)	35	4B	S.C	1997	M

High Voltage – Fast Recovery Diodes

◆Resin Molded Type

Type	Absolute maximum ratings				Characteristics		Outline	RoHS Status	Production year	Production status
	V _{RRM} (kV)	* I _{F(AV)} (mA)	I _{FSM} (A)	T _j (°C)	V _{FM} (at I _{FM}) (V) (mA)	t _{rr} (ns)				
DHM3T30	3	3 [15.75]	0.5	-40 ~ +120	13 (5)	100	1B	S.C	1989	M
DHM3P40	4				13 (5)	100	1B	S.C	1989	M
DHM3G80	8				25 (5)	100	1F	S.C	1999	M
DHM3J120	12				42 (5)	100	1G	S.C	1999	M
DHM3C140	14				45 (5)	100	1H	S.C	1999	N
DHM3FJ60	6	1 [63]	0.5		22 (5)	70	1F	S.C	1999	M
DHM3FG80	8	3 [15.75]			28 (5)	70	1F	S.C	1999	M
DHM3UM80	8	1 [100] 3 [15.75]	0.5		23 (5)	40	1F	S.C	1998	M

* [] : Frequency, unit (kHz)

High Voltage – Fast Recovery Diodes (For Automotive)

◆Resin Molded Type

Type	Absolute maximum ratings				Characteristics		Outline	RoHS Status	Production year	Production status
	V _{RRM} (kV)	I _{F(AV)} (mA)	I _{FSM} (A)	T _j (°C)	V _{FM} (at I _{FM}) (V) (mA)	t _{rr} (ns)				
DHM10A30	3.0	10	1	+150	8.4 (10)	-	1K	S.C	2011	M
DHM30A10	1.0	30	3		2.0 (10)	-	1M	S.C	2013	M
DHM30A20	2.0	30	3		5.0 (10)	-	1M	S.C	2013	M
DHM30A25	2.5	30	3		5.0 (10)	-	1M	S.C	2014	M
DHM30A30	3.0	30	3		6.0 (10)	-	1F	S.C	2013	M
DHM30A40	4.0	30	3		10.0 (10)	-	1L	S.C	2011	M

High Voltage – Fast Recovery Diodes (For Automotive) Lead(Pb)-Free

◆Resin Molded Type

Type	Absolute maximum ratings				Characteristics		Outline	RoHS Status	Production year	Production status
	V _{RRM} (kV)	I _{F(AV)} (mA)	I _{FSM} (A)	T _j (°C)	V _{FM} (at I _{FM}) (V) (mA)	t _{rr} (ns)				
DHM30A10E	1.0	30	3	+150	2.0 (10)	-	1M	C	2017	M
DHM30A20E	2.0	30	3		5.0 (10)	-	1M	C	2017	M
DHM30A25E	2.5	30	3		5.0 (10)	-	1M	C	2016	M
DHM30A30E	3.0	30	3		6.0 (10)	-	1F	C	2017	M
DHM30A40E	4.0	30	3		10.0 (10)	-	1L	C	2017	M

Alternator Diodes

◆ Super Low Loss Diodes

Type	Absolute maximum ratings		Characteristics			Outline	RoHS Status	Production year	Production status
	IF(AV) (A)	Tj (°C)	Vz (V)		VFM (at IFM) (V) (A)				
			Min.	Max.					
MSM35J22	35	-40~+175	20	24	0.3 (100)	10	S.C	-	E
MSM35J22R									
MSM50J22	50	-40~+175	20	24	0.12 (100)	10	S.C	-	E
MSM50J22R									

◆ Standard Type Diodes

Type	Absolute maximum ratings		Characteristics			Outline	RoHS Status	Production year	Production status		
	IF(AV) (A)	Tj (°C)	Vz (V)		VFM (at IFM) (V) (A)						
			Min.	Max.							
ZSM35C22	35	-40~+205	20	23	1.3 (100)	9A	S.C	2013	M		
ZSM35C22R						9C					
ZSM50C22	50				20	24		1.2 (100)	9A	2012	M
ZSM50C22R									9C		
ZSM70A22	70 (Tc ≤ 205°C)	-40~+225	20	24	1.2 (100)	9A	2013	M			
ZSM70A22R	50 (Tc ≤ 225°C)					9C					

Discontinued

◆ General-Use Rectifier Diodes

Type	Absolute maximum ratings				Characteristics		Outline	RoHS Status	Production year	Production status	
	VRRM (V)	IF(AV) (A)	IFSM (A)	Tj (°C)	V _{FM} (at I _{FM}) (V) (A)	t _{rr} (ms)					
H14A	100	1.0	45	-40 ~+175	1.0 (1.0)	-	2A	S.C	1989	D *	
B	200										
C	300										
D	400										
E	500										
F	600										
H	800										
J	1,000										
V06C	200	1.1	35	-65 ~+175	1.4 (1.1)	-	2A	S.C	1976	D *	
E	400										
G	600										
J	800										
V03C	200	1.3	40		1.1 (1.3)	-	2A	S.C	1975		D *
E	400										
G	600										
J	800										
U05B	100	2.5	100		1.1 (2.5)	-	2B	S.C	1975	D *	
C	200										
E	400										
G	600										
J	800										
U15B	100	3	80	1.0 (3.0)	-	2B	S.C	1978	D *		
C	200										
E	400										
G	600										
J	800										

◆ Zener Diodes

Type	Absolute maximum ratings			Characteristics			Outline	RoHS Status	Production year	Production status
	P (W)	PRSM (Wp)	Tj (°C)	Vz (V)		Test Current (mA)				
				Min.	Max.					
AW01-06	1.0	80	-40 ~+150	5.2	6.8	60	2A	S.C	1976	D *
AW01/AU01-07	1.0/2.5	80/160	-40 ~+150 / -40 ~+165	6.2	7.9	25/65	2A/2B	S.C/S.C	1976	D * / D *
08				7.7	8.7	25/65				
09				8.5	9.6	25/65				
10				9.4	10.6	25/65				
11				10.4	11.6	25/65				
12				11.4	12.7	25/65				
13				12.4	14.1	25/65				
15				13.5	15.6	15/40				
16				15.3	17.1	15/40				
18				16.8	19.1	15/40				
20				18.8	21.2	15/40				
22				20.8	23.3	15/40				
24				22.7	25.6	10/25				
27				25.1	28.9	10/25				
30				28.0	32.0	10/25				
33	31.0	35.0	10/25							

* EOL notices was issued in July 2018, Last buy order is closed in June 2019.

Discontinued

◆Fast Recovery Diodes

Type	Absolute maximum ratings				Characteristics		Outline	RoHS Status	Production year	Production status
	V _{RRM} (V)	I _{F(AV)} (A)	I _{FSM} (A)	T _J (°C)	V _{FM} (at I _{FM}) (V) (A)	t _{rr} (ms)				
DFG1D1	100	1.0	30	-65 ~+150	1.5 (1.0)	50ns	2A	S.C	1986	D *
2	200									
4	400									
DFG1C1	100	1.0	35		1.2 (1.0)	0.1	2A	S.C	1985	D *
2	200									
4	400									
6	600		30		1.6 (1.0)					
8	800									
DFG3A1	100	3.0	70		1.3 (3.0)	0.1	2B	S.C	1985	D *
2	200									
4	400									
V19B	100	1.0	30	1.2 (1.0)	0.2	2A	S.C	1977	D *	
C	200									
E	400									
G	600									
DFG1A8	800	1.0	40	-65 ~+165	1.2 (1.0)	0.2	2A	S.C	1982	D *
H114B	200	1.0	40	-40 ~+150	1.15 (1.0)	0.2	2A	S.C	1989	D *
D	400									
E	500									
F	600									
U19B	100	2.5	80	-65 ~+150	1.3 (2.5)	0.2	2B	S.C	1978	D *
C	200									
E	400									
DFG2A6	600	2.5	80	-65 ~+165	1.3 (2.5)	0.2	2B	S.C	1982	D *
8	800									
V11J	800	0.4	30	-65 ~+150	2.5 (0.4)	0.4	2A	S.C	1975	D *
L	1,000									
M	1,300									
N	1,500									
V09C	200	0.8	35	-65 ~+165	1.6 (0.8)	0.4	2A	S.C	1975	D *
E	400									
G	600									
U07J	800	1.0	50	-65 ~+140	2.5 (1.0)	0.4	2B	S.C	1975	D *
L	1,000									
M	1,300									
N	1,500									
U06C	200	2.0	80	-65 ~+150	1.2 (2.0)	0.4	2B	S.C	1975	D *
E	400									
G	600									

◆Controlled Avalanche Diodes

Type	Absolute maximum ratings					Characteristics		Outline	RoHS Status	Production year	Production status
	V _{RRM} (V)	I _{F(AV)} (A)	P _{RM} (W)	I _{FSM} (A)	T _J (°C)	V _{FM} (at I _{FM}) (V) (A)					
H24F	600	1.0	1,000	45	-65 ~+175	1.0 (1.0)	2A	S.C	1989	D *	
H	800										
J	1,000				-65 ~+165						
V08E	400	1.1	40	35	-65 ~+175	1.4 (1.1)	2A	S.C	1975	D *	
G	600										
J	800										
V07E	400	1.3	40	40	-65 ~+175	1.1 (1.3)	2A	S.C	1975	D *	
G	600										
J	800										
V17A	50	1.3	1,500	50	-40 ~+165	1.1 (1.3)	2A	S.C	1975	D *	
B	100										
C	200										
D	300										
E	400										
U17B	100	2.5	3,000	100	-40 ~+175	1.1 (2.5)	2B	S.C	1975	D *	
C	200										
D	300										
E	400										

* EOL notices was issued in July 2018, Last buy order is closed in June 2019.

Discontinued

◆ Surge Suppressor Diodes

Type	Absolute maximum ratings			Characteristics			Outline	RoHS Status	Production status
	PRSM (kW)	V _{DC} (V)	T _j (°C)	V _Z (V)		Test Current (mA)			
				Min.	Max.				
DAM1MA/3MA10	0.6/1.8	-40 ~ +150	7	9.4	10.6	25/75	4A/4C	S.C	D
11			10.4	11.6	25/75	D *			
12			11.4	12.7	25/75				
13			12.4	14.1	25/75				
15			13.5	15.6	25/75				
16			15.3	17.1	15/75				
18			16.8	19.1	15/45				
20			18.8	21.2	15/45				
22			20.8	23.3	15/45				
24			22.7	25.6	10/30				
27			25.1	28.9	10/30				
30			28.0	32.0	10/30				
33			31.0	35.0	10/30				
36			33.4	38.6	10/30				
39			36.1	41.9	10/20				
43			39.8	46.2	6/20				
47			43.3	50.7	6/20				
51			46.9	55.1	6/20				
68			61.2	74.8	4/10				
75			67.5	82.5	4/10				
82			73.8	90.2	3/10				

◆ General-Use Rectifier Diodes

Type	Absolute maximum ratings				Characteristics		Outline	RoHS Status	Production status
	V _{RRM} (V)	* I _{F(AV)} (A)	I _{FSM} (A)	T _j (°C)	V _{FM} (at I _{FM}) (V) (A)	t _{rr} (ms)			
DSA3A1	100	3.0	120	-40 ~ +150	1.0 (3.0)	-	2C	S.C	D
2	200								
4	400								

◆ General-Use Rectifier Diodes

Type	Absolute maximum ratings				Characteristics		Outline	RoHS Status	Production status
	V _{RRM} (V)	* I _{F(AV)} (A)	I _{FSM} (A)	T _j (°C)	V _{FM} (at I _{FM}) (V) (A)	t _{rr} (ms)			
DSM1MA1	100	1.0	25	-40 ~ +150	1.1 (1.0)	-	4A	S.C	D *
2	200								
4	400								
DSM3MA1	100	3.0	80	-40 ~ +150	1.0 (3.0)	-	4B	S.C	D *
2	200								
4	400								

* EOL notices was issued in July 2018, Last buy order is closed in June 2019.

Discontinued

◆ Surge Suppressor Diodes

Type	Absolute maximum ratings			Characteristics			Outline	RoHS Status	Production status							
	PRSM (kW)	V _{DC} (V)	T _j (°C)	V _Z (V)		Test Current (mA)										
				Min.	Max.											
DAM1SA/1A10	0.6		-40 ~+150	7	9.4	10.6	25	1A/1B	S.C / S.C	D / D						
11				10.4	11.6	25										
12				11.4	12.7	25										
13				12.4	14.1	25										
15				13.5	15.6	25										
16				15.3	17.1	15										
18				16.8	19.1	15										
20				18.8	21.2	15										
22				20.8	23.3	15										
24				22.7	25.6	10										
27				25.1	28.9	10										
30				28.0	32.0	10										
33				31.0	35.0	10										
36				33.4	38.6	10										
39				36.1	41.9	10										
43				39.8	46.2	6										
47				43.3	50.7	6										
51				46.9	55.1	6										
DAM3A/3B10				1.8		-40 ~+150	7				9.4	10.6	75	1E/1D	S.C / S.C	D / D
11							10.4				11.6	75				
12	11.4	12.7	75													
13	12.4	14.1	75													
15	13.5	15.6	75													
16	15.3	17.1	75													
18	16.8	19.1	45													
20	18.8	21.2	45													
22	20.8	23.3	45													
24	22.7	25.6	30													
27	25.1	28.9	30													
30	28.0	32.0	30													
33	31.0	35.0	30													
36	33.4	38.6	30													
39	36.1	41.9	30													
43	39.8	46.2	20													
47	43.3	50.7	20													
51	46.9	55.1	20													

◆ High Voltage – Fast Recovery Diodes

Type	Absolute maximum ratings				Characteristics		Outline	RoHS Status	Production status
	V _{RRM} (kV)	* I _{F(AV)} (mA)	I _{FSM} (A)	T _j (°C)	V _{FM} (at I _{FM}) (V)	t _{rr} (ns)			
DHM3S20	2	3 [15.75]	0.5	-40 ~+120	10 (5)	100	1B	S.C	D
DHM3UG120	12	1 [100] 3 [15.75]			36 (5)	40	1G	S.C	D

* []: Frequency, unit (kHz)

◆ Load Dump Surge Suppressor Diodes

Type	Absolute maximum ratings			Characteristics			Outline	RoHS Status	Production status
	PRSM (kW)	V _{DC} (V)	T _j (°C)	V _Z (V)		I _Z (mA)			
				Min.	Max.				
ZSA5A27	3.0kW		-40 ~+150	24.0	30.0	10	3A	S.C	D
ZSA5MA27							62A	3B	S.C

◆ Fast Recovery Diodes

Type	Absolute maximum ratings				Characteristics		Outline	RoHS Status	Production status
	V _{RRM} (kV)	* I _{F(AV)} (A)	I _{FSM} (A)	T _j (°C)	V _{FM} (at I _{FM}) (V)	t _{rr} (ms)			
DFG1E 6	600	0.3	5	-65 ~+150	5.0(0.3)	35ns	2A	S.C	D
8	800								
10	1,000								

Outline

[Dimensions in mm]

● Outline No.1

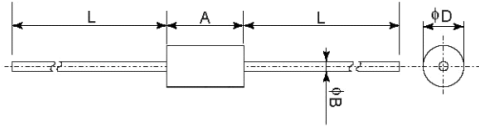

Items	A	φD	φB	L (Min.)
1A	3	2.5	0.6	28
1B	5	2.65	0.6	27
1C	5	2.65	0.8	27
1D	6	3.6	0.8	26
1E	7.5	6.4	1.2	26
1F	6.5	2.5	0.5	28
1G	10	2.5	0.5	26
1H	10	3	0.6	26,28
1J	8	3	0.6	28
1K	6.5	2.5	0.5	27
1L	8	3	0.6	27
1M	5	2.5	0.5	27

● Outline No.2

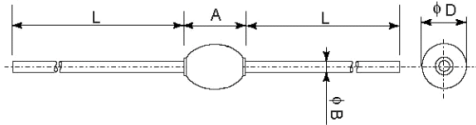

Items	A (Max.)	φD (Max.)	φB	L (Min.)
2A	5	3.5	0.8	29
2B	7	5	1.2	28
2C	7	5	1.2	27

● Outline No.3A

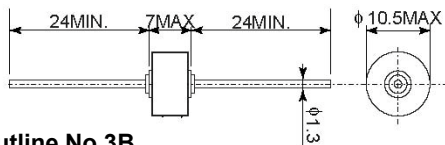

● Outline No.3B

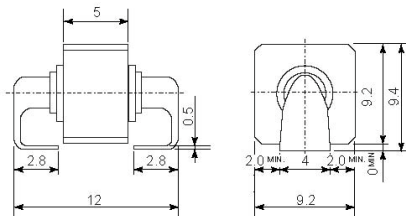

● Outline No.4

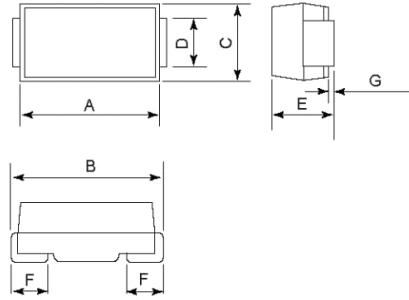

Items	A	B	C	D	E	F	G
4A	4.3	4.7	2.5	1.5	2.0	1.2	0.1
4B	4.4	5.4	3.6	2.0	2.3	1.2	0.2
4C	7.0	7.6	4.0	2.0	2.5	1.4	0.2

● Outline No.5

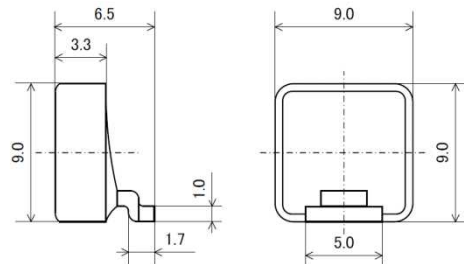

● Outline No.6

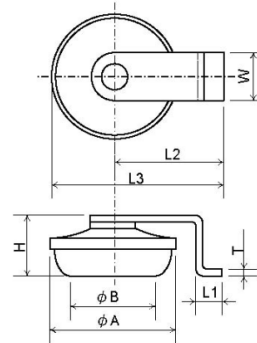

● Outline No.7A, 7B

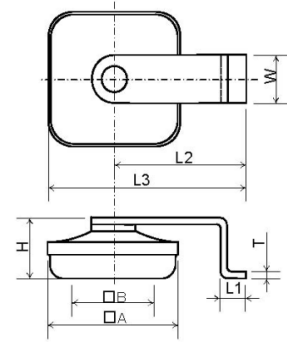

Items	A	B	L1	L2	L3	H	W	T
6A	9.6	7.4	2.0	8.3	13.1	4.4	3.5	0.5
6B*	9.6	-	2.0	8.3	13.1	6.0	3.5	0.5
7A	10.0	7.5	2.0	10.0	15.0	4.4	3.5	0.5
7B**	10.0	7.5	2.0	10.0	15.0	4.4	2.7	0.5

*Packages is different

**JEDEC DO-218AB Compatible

Outline

[Dimensions in mm]

● Outline No.8

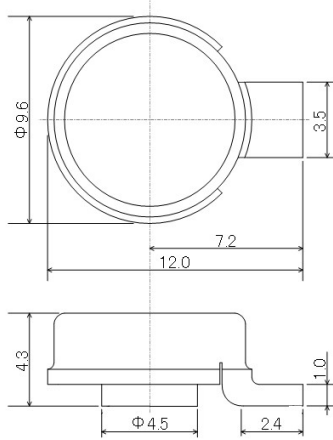

● Outline No.9A, 9B, 9C, 9D

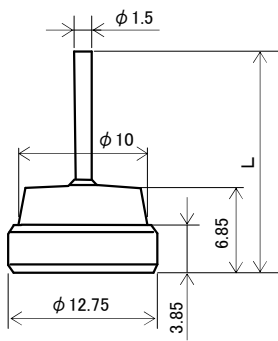

Items	L
9A	19.2
9B	28.5
9C	17.0

● Outline No.10

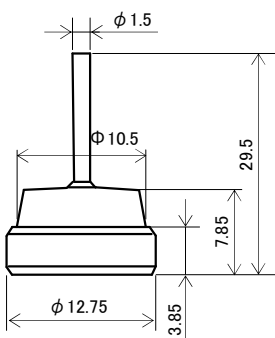

Notices

1. The information given herein, including the specifications and dimensions, is subject to change without prior notice to improve product characteristics. Before ordering, purchasers are advised to contact Hitachi Power Semiconductor Device (HPSD) sales department for the latest version of data sheets.
2. Please be sure to read "Precautions for Safe Use and Notices" in the individual brochure before use.
3. Very high reliability is in a use. (such as use in nuclear power control, aerospace and aviation, life-support-related medical equipment, fuel control equipment and various kinds of safety equipment), Please do not use it.
4. In no event shall HPSD be liable for any damages that may result from an accident or any other cause during operation of the user's units according to this data sheets. HPSD assumes no responsibility for any intellectual property claims or any other problems that may result from applications of information, products or circuits described in this data sheets.
5. In no event shall HPSD be liable for any failure in a semiconductor device or any secondary damage resulting from use at a value exceeding the absolute maximum rating.
6. No license is granted by this data sheets under any patents or other rights of any third party or Hitachi Power Semiconductor Device, Ltd.
7. This data sheets may not be reproduced or duplicated, in any form, in whole or in part , without the expressed written permission of Hitachi Power Semiconductor Device, Ltd.
8. The products (technologies) described in this data sheets are not to be provided to any party whose purpose in their application will hinder maintenance of international peace and safety not are they to be applied to that purpose by their direct purchasers or any third party. When exporting these products (technologies), the necessary procedures are to be taken in accordance with related laws and regulations.

HITACHI

■ HITACHI POWER SEMICONDUCTOR DEVICE OVERSEAS REPRESENTATIVES

United States of America

Hitachi America, Ltd.
Industrial and Infrastructure Systems Division
50 Prospect Avenue Tarrytown, NY 10591
Telephone:<1>(914) 631-0600
Fax :<1>(914) 631-3672

Korea

Hitachi Korea Ltd.
10th Floor, Young Poong Bldg., 41, Cheonggyecheon-ro,
Jongno-gu, Seoul, 03188, Korea
Telephone:<82>(2) 6050-8564
Fax :<82>(2) 6050-8569

United Kingdom

Hitachi Europe Ltd. Power Device Division
Whitebrook Park, Lower Cookham Road, Maidenhead
Berkshire SL6 8YA
Telephone:<44>(1628) 585151
Mail : pdd@hitachi-eu.com
Webpage : <http://pdd.hitachi.eu/>

Thailand

Hitachi Asia (Thailand) Co., Ltd.
12th Floor, Ramaland Bldg, No.952, Rama IV Road, Suriyawongse,
Bangrak, Bangkok 10500, Thailand
Telephone:<66>(2) 632-9292
Fax :<66>(2) 632-9299

Shanghai

Hitachi (China) Ltd. Shanghai Branch
18th Floor, Rui Jin Building, No.205, Maoming Road (S)
Shanghai 200020, China
Telephone:<86>(21) 6472-1002
Fax :<86>(21) 6472-9080

India

Hitachi India Pvt. Ltd.
Ground & First floor, Tower B, World Mark 1,
Asset Number 11, Aerocity, NH-8, New Delhi-110037, India
Telephone:<91>(11) 4060-5252
Fax :<91>(11) 4060-5253

Hong Kong

Hitachi East Asia Ltd.
8/F, Building 20E, Phase 3, Hong Kong Science Park,
Pak Shek Kok, New Territories, Hong Kong
Telephone:<852>2735-9218
Fax :<852>2375-3192

- For inquiries relating to the product, please contact above overseas representatives or below.

Hitachi Power Semiconductor Device, Ltd.

Sales Department, Business Management Division TEL:<81>(3)4564-5147 FAX:<81>(3)4564-6251
Akihabara Daibiru Building, 18-13 Soto-Kanda 1-chome URL; <http://www.hitachi-power-semiconductor-device.co.jp/en/>
Chiyoda-ku, Tokyo, 101-8608 Japan

お問い合わせ先

株式会社 日立パワーデバイス

東京本社

〒101-8010 東京都千代田区外神田一丁目18番13号(秋葉原ダイビル)

(03) 4564-5147

ホームページ : <http://www.hitachi-power-semiconductor-device.co.jp>

■製品に対する問い合わせは、上記の担当営業所または下記へどうぞ。

株式会社日立パワーデバイス ビジネスマネジメント本部

〒101-8608 東京都千代田区外神田一丁目18番13号(秋葉原ダイビル) TEL (03)4564-5147 FAX (03)4564-6251

ご注意

1. 本資料に掲載した内容は、予告なく変更することがありますのでご了承ください。
2. 製品ご使用の前に「使用上の注意」をよくお読みのうえ、正しくご使用下さい。
3. 極めて高い信頼性が要求される用途（原子力制御用、航空宇宙用、交通機器、ライフサポート関連の医療機器、燃焼制御機器、各種安全機器など）に使用される場合は、特に高信頼性が確保された半導体デバイスの使用及び使用側でフェイルセーフなどを配慮した安全性確保をして下さい。または当社営業窓口にご照会下さい。
4. 本資料に記載された情報、製品や回路の使用に起因する損害または特許権その他権利の侵害に関しては、当社は一切その責任を負いません。
5. 絶対最大定格値を越えてご使用された場合の半導体デバイスの故障及び二次的損害につきましては、弊社はその責任を負いません。
6. 本資料によって第三者または株式会社日立パワーデバイスの特許権その他権利の一部を許諾するものではありません。
7. 本資料の一部または全部を当社に無断で転載または複製する事を堅くお断り致します。
8. 本資料に記載された製品（技術）を国際的平和および安全の維持の妨げとなる使用目的を有する者に再提供したり、またそのような目的に自ら使用したり第三者に使用させたりしないようお願いいたします。なお、輸出などされる場合は外為法の定めるところに従い必要な手続きをおとりください。