

MBN1800F33F-C3

3300V Silicon N-channel IGBT F version with SiC Diode

FEATURES

- * Soft switching & low conduction loss IGBT :
Soft low-injection punch-through
High conductivity IGBT with advanced trench MOS gate.
- * Low driving power due to low input capacitance.
- * Ultra low recovery loss with SiC diode.
- * High Current rate Package.
- * Low stray inductance.
- * RoHS

ABSOLUTE MAXIMUM RATINGS (T_c=25°C)

Item	Symbol	Unit	MBN1800F33F-C3
Collector Emitter Voltage	V _{CES}	V	3,300
Gate Emitter Voltage	V _{GES}	V	±20
Collector Current	DC	I _c	1,800
	1ms	I _{cp}	3,600
Forward Current	DC	I _F	1,800
	1ms	I _{FM}	3,600
Junction Temperature	T _j	°C	-40 ~ +150
Storage Temperature	T _{stg}	°C	-40 ~ +150
Isolation Voltage	V _{ISO}	V _{RMS}	6,000(AC 1 minute)
Screw Torque	Terminals (M4/M8)	-	2/15 (1)
	Mounting (M6)	-	6 (2)

Notes: (1) Recommended Value 1.8±0.2/15^{+0.3}N·m

(2) Recommended Value 5.5±0.5N·m

ELECTRICAL CHARACTERISTICS

Item	Symbol	Unit	Min.	Typ.	Max.	Test Conditions
Collector Emitter Cut-Off Current	I _{CES}	mA	-	-	18	V _{CE} =3,300V, V _{GE} =0V, T _j =25°C
			-	38	-	V _{CE} =3,300V, V _{GE} =0V, T _j =150°C
Gate Emitter Leakage Current	I _{GES}	nA	-500	-	+500	V _{GE} =±20V, V _{CE} =0V, T _j =25°C
Collector Emitter Saturation Voltage	V _{CE(sat)}	V	-	2.85	-	I _c =1,800A, V _{GE} =15V, T _j =150°C
Gate Emitter Threshold Voltage	V _{GE(TO)}	V	5.5	6.5	7.5	V _{CE} =10V, I _c =1,800mA, T _j =25°C
Input Capacitance	C _{ies}	nF	-	132	-	V _{CE} =10V, V _{GE} =0V, f=100kHz, T _j =25°C
Internal Gate Resistance	R _{g(int)}	Ω	-	1.3	-	V _{CE} =10V, V _{GE} =0V, f=100kHz, T _j =25°C
Turn On Delay Time	t _{d(on)}	μs	-	0.8	-	V _{CC} =1,800V, I _c =1,800A
Rise Time	t _r		-	0.3	-	L _s =80nH
Turn Off Delay Time	t _{d(off)}		-	2.5	-	R _{G(on/off)} =4.7/5.6Ω (3)
Fall Time	t _f		-	1.7	-	V _{GE} =±15V, T _j =150°C
Peak Forward Voltage Drop	V _{FM}	V	-	4.6	-	I _F =1,800A, V _{GE} =0V, T _j =150°C
Reverse Recovery Time	t _{rr}	μs	-	0.1	-	V _{CC} =1,800V, I _F =1,800A, L _s =80nH T _j =150°C
Turn On Loss	E _{on}	J/P	-	2.1	-	V _{CC} =1,800V, I _c (I _F)=1,800A, L _s =80nH
Turn Off Loss	E _{off}	J/P	-	3.3	-	R _{G(on/off)} =4.7/5.6Ω (3)
Reverse Recovery Loss	E _{rr}	J/P	-	(0.15)	-	V _{GE} =±15V, T _j =150°C
Stray inductance module	L _{SCE}	nH	-	7	-	
Thermal Impedance	IGBT	R _{th(j-c)}	-	-	0.0067	Junction to case
	FWD	R _{th(j-c)}	-	-	0.012	
Contact Thermal Impedance	R _{th(c-f)}	K/W	-	0.005	-	Case to fin

Notes: (3) R_G value is a test condition value for evaluation, not recommended value.

Please, determine the suitable R_G value by measuring switching behaviors.

- * Please contact our representatives at order.
- * For improvement, specifications are subject to change without notice.
- * For actual application, please confirm this spec sheet is the newest revision.
- * ELECTRICAL CHARACTERISTIC items shown in above table are according to IEC 60747-2 and IEC 60747-9.

MBN1800F33F-C3

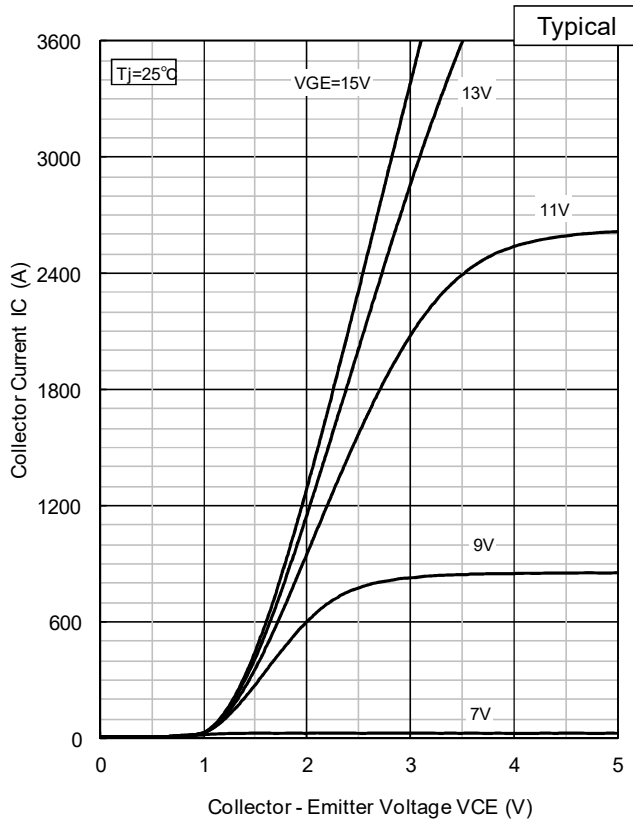

I_C vs. V_{CE} ($T_j=25^{\circ}\text{C}$)

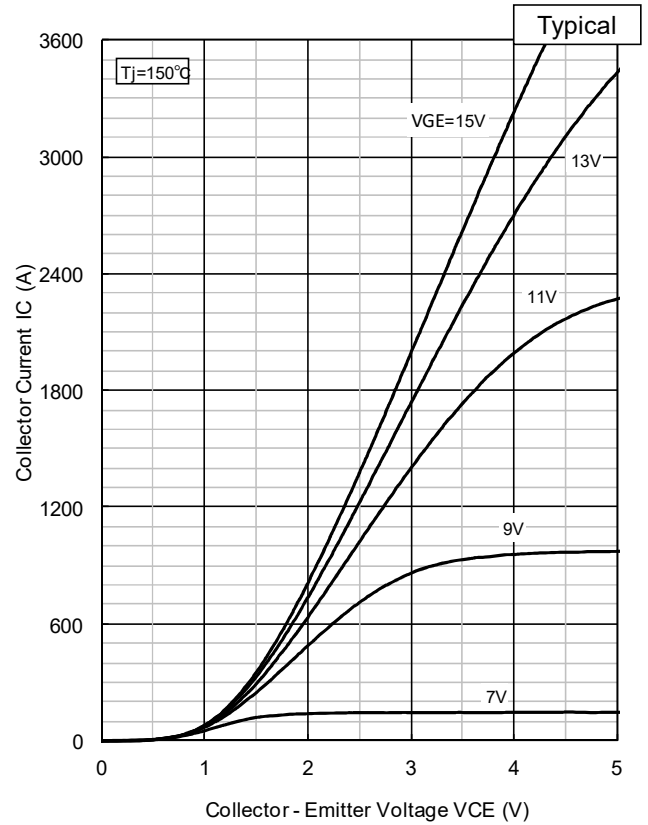

I_C vs. V_{CE} ($T_j=150^{\circ}\text{C}$)

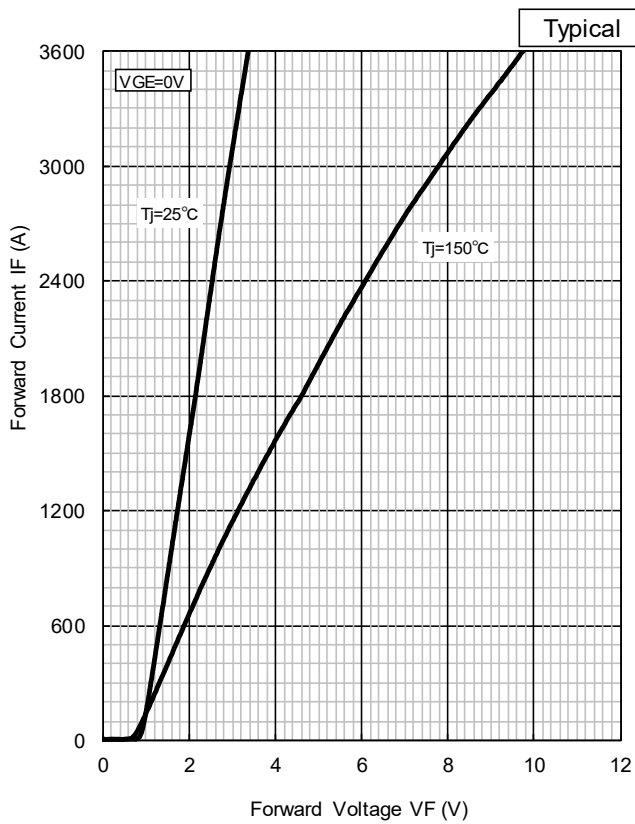

I_F vs. V_F

MBN1800F33F-C3

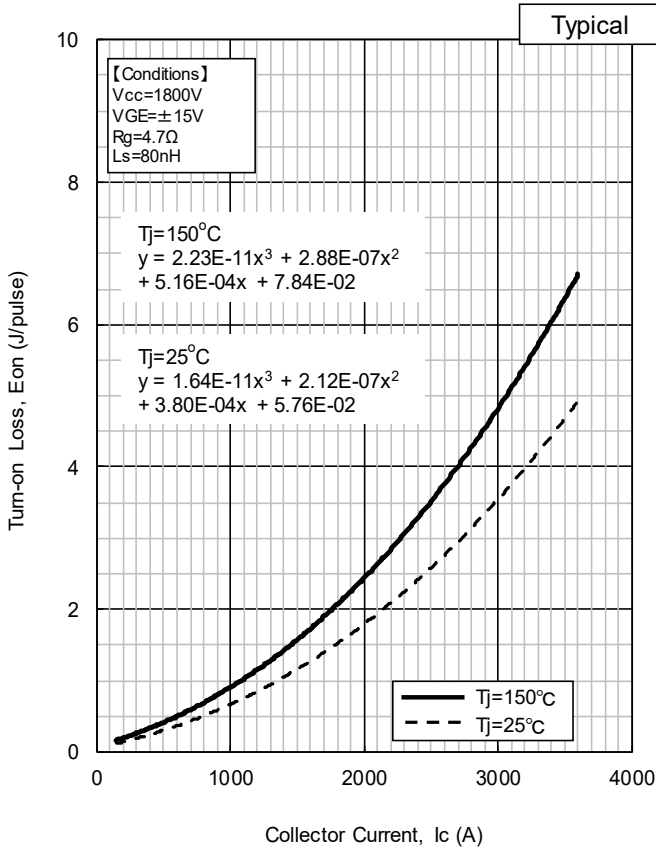

Turn-on loss vs. Collector current

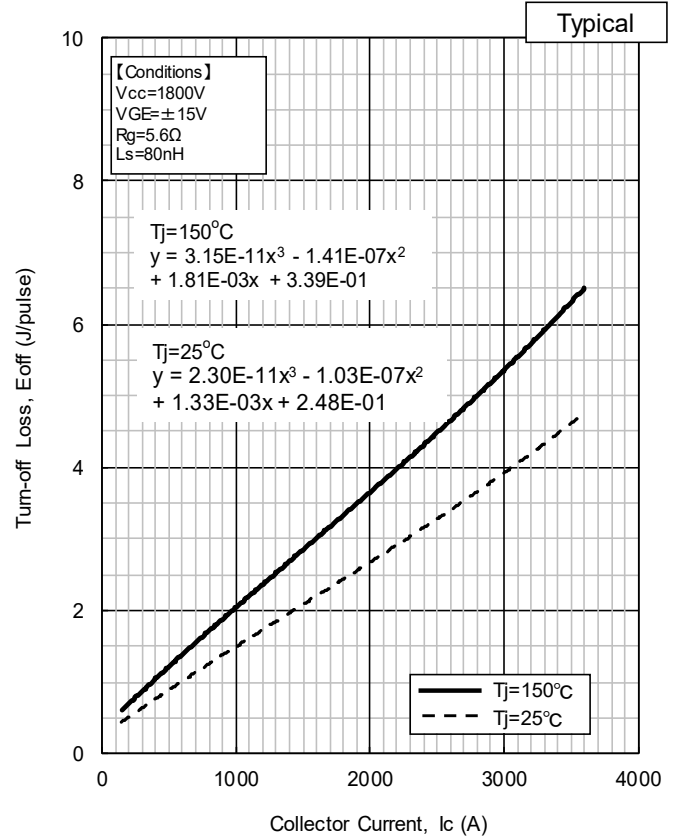

Turn-off loss vs. Collector current

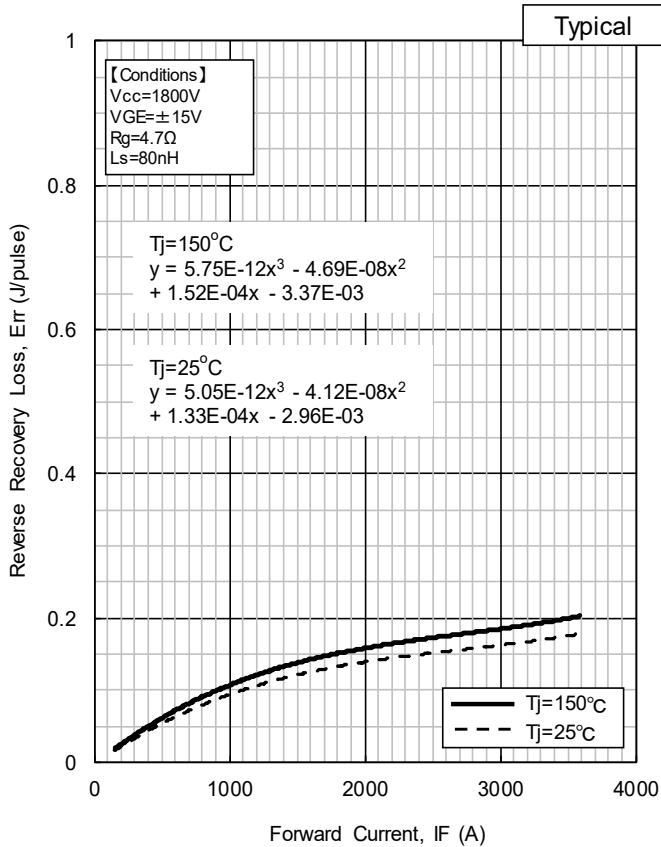

Recovery loss vs. Forward current

MBN1800F33F-C3

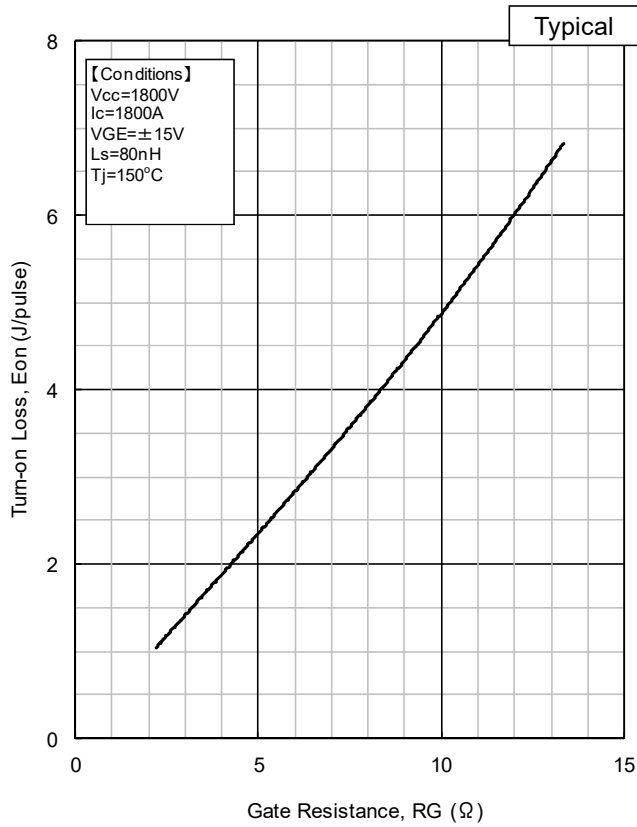

Turn-on loss vs. Gate Resistance

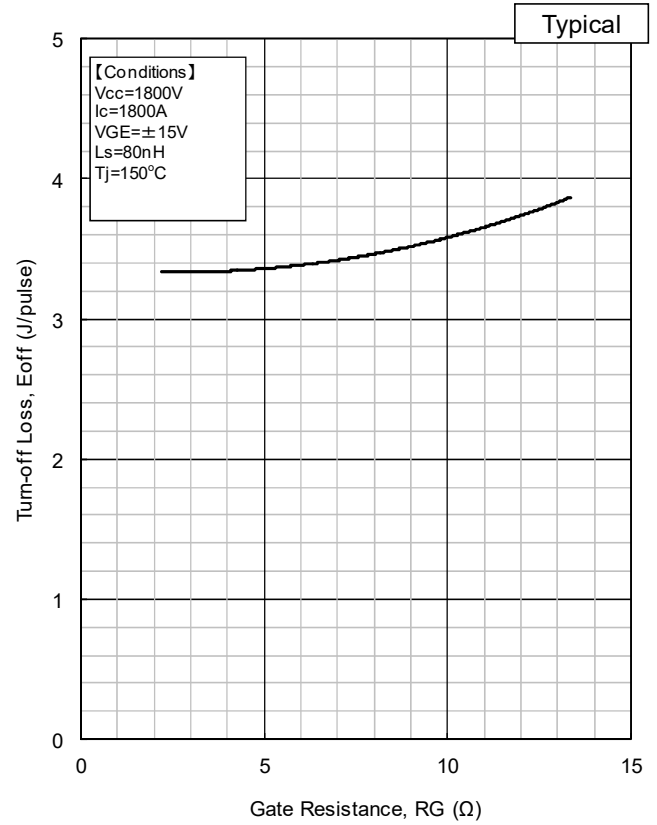

Turn-off loss vs. Gate Resistance

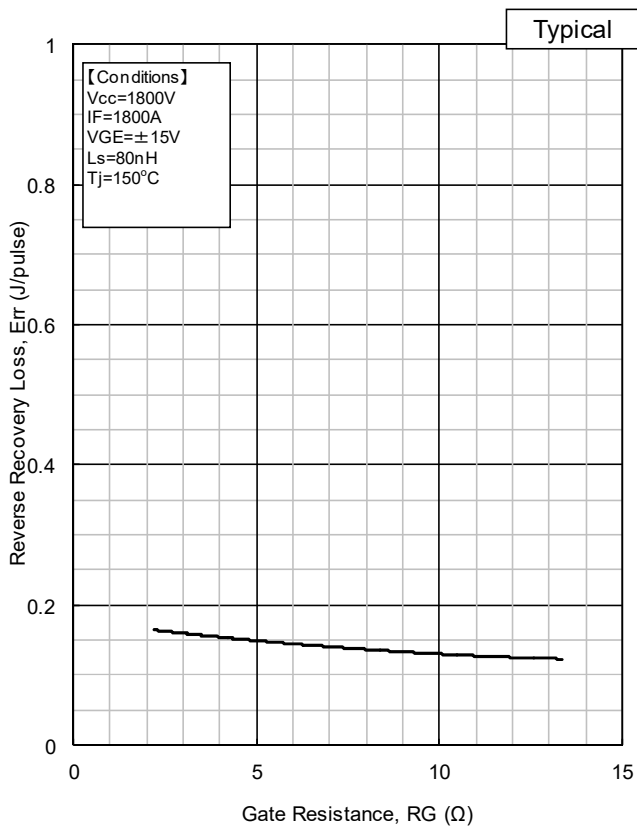

Recovery loss vs. Gate Resistance

MBN1800F33F-C3

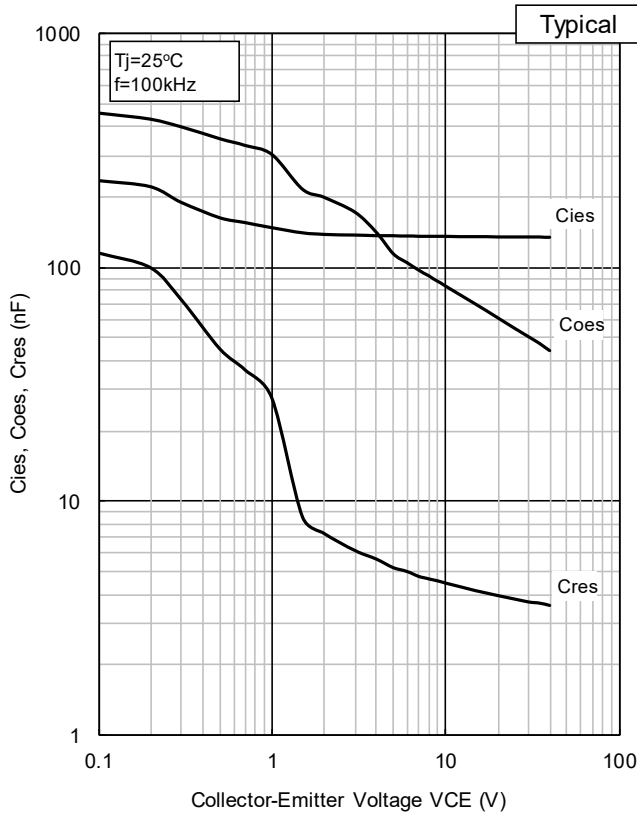

Cies, Coes, Cres - VCE

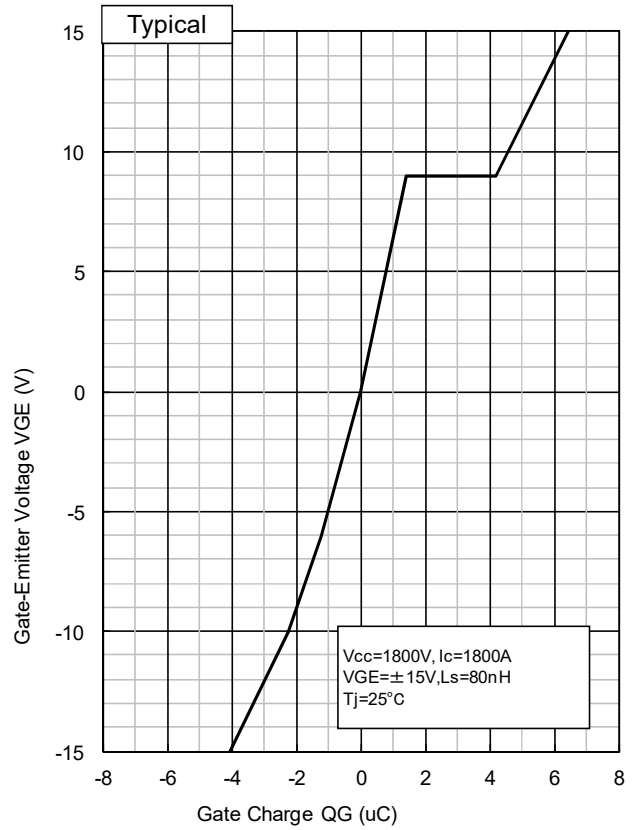

QG - VGE

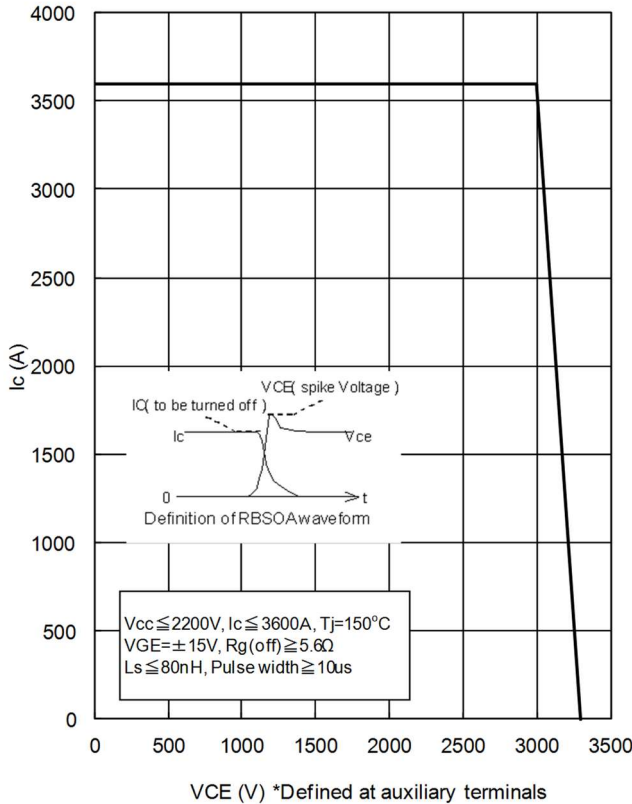

RBSOA

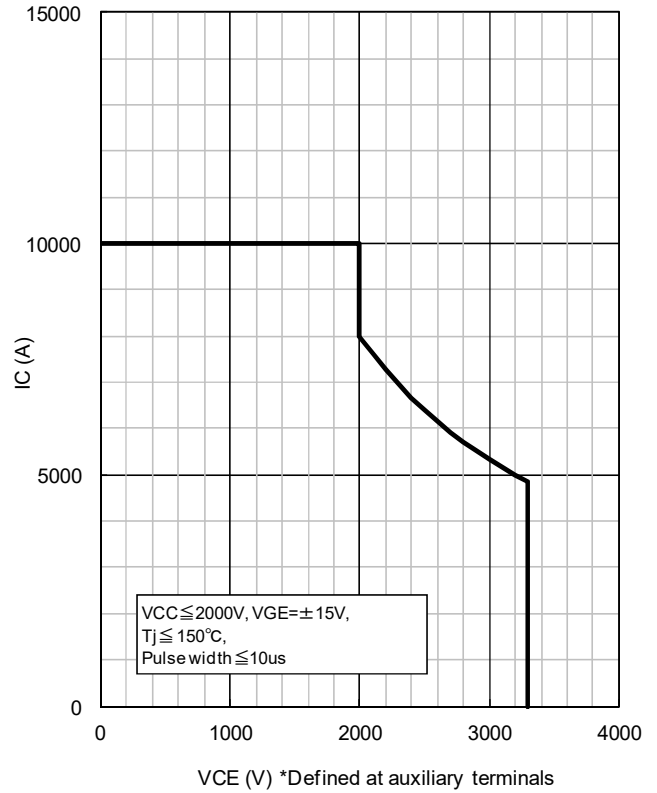

SCSOA

MBN1800F33F-C3

TRANSIENT THERMAL IMPEDANCE

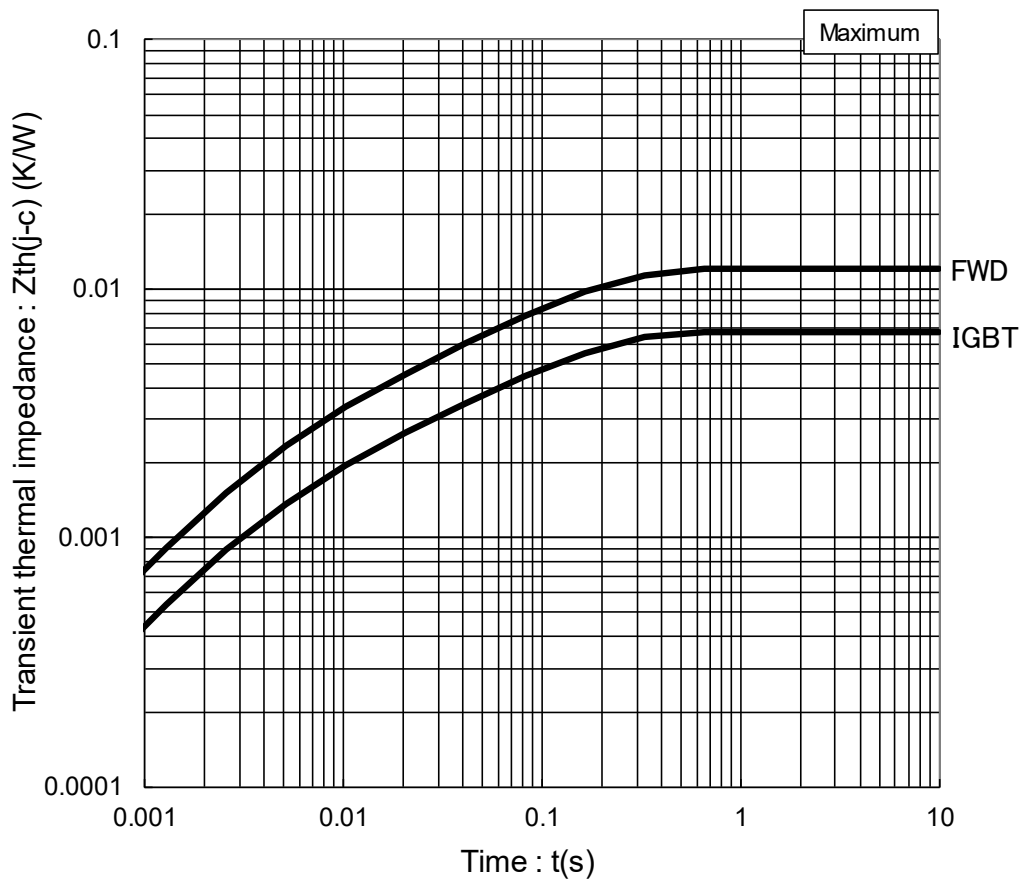

Transient Thermal Impedance Curve

Curve approximation model

$$\sum Z_{th}[n] * (1 - \exp(-t/\tau_{th}[n]))$$

n	1	2	3	4	Unit
$\tau_{th}[n]$	0.003	0.03	0.1	0.3	sec
$Z_{th}[n,IGBT]$	1.36E-03	7.88E-04	4.11E-03	4.49E-04	K/W
$Z_{th}[n,Diode]$	2.26E-03	1.62E-03	6.71E-03	1.41E-03	K/W

MBN1800F33F-C3

OUTLINE DRAWINGS

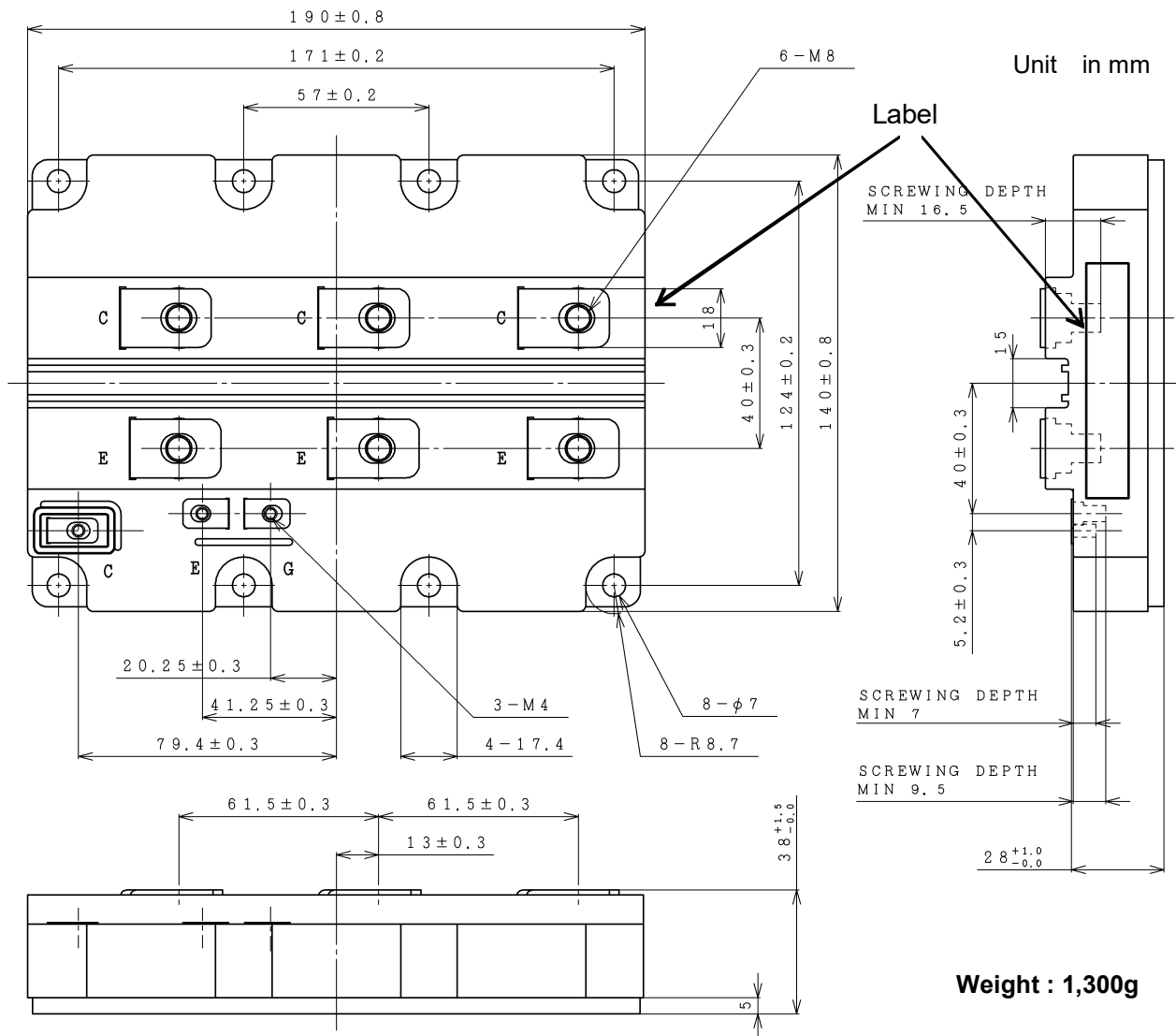

Fig.1 Outline Drawings

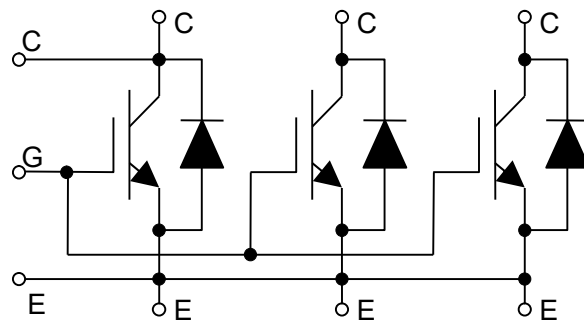

Fig.2 Circuit diagram

MBN1800F33F-C3

HITACHI POWER SEMICONDUCTORS

Notices

1. The information given herein, including the specifications and dimensions, is subject to change without prior notice to improve product characteristics. Before ordering, purchasers are advised to contact Hitachi sales department for the latest version of this data sheets.
2. Please be sure to read "Precautions for Safe Use and Notices" in the individual brochure before use.
3. In cases where extremely high reliability is required (such as use in nuclear power control, aerospace and aviation, traffic equipment, life-support-related medical equipment, fuel control equipment and various kinds of safety equipment), safety should be ensured by using semiconductor devices that feature assured safety or by means of users' fail-safe precautions or other arrangement. Or consult Hitachi's sales department staff.
4. In no event shall Hitachi be liable for any damages that may result from an accident or any other cause during operation of the user's units according to this data sheets. Hitachi assumes no responsibility for any intellectual property claims or any other problems that may result from applications of information, products or circuits described in this data sheets.
5. In no event shall Hitachi be liable for any failure in a semiconductor device or any secondary damage resulting from use at a value exceeding the absolute maximum rating.
6. No license is granted by this data sheets under any patents or other rights of any third party or Hitachi Power Semiconductor Device, Ltd.
7. This data sheets may not be reproduced or duplicated, in any form, in whole or in part, without the expressed written permission of Hitachi Power Semiconductor Device, Ltd.
8. The products (technologies) described in this data sheets are not to be provided to any party whose purpose in their application will hinder maintenance of international peace and safety not are they to be applied to that purpose by their direct purchasers or any third party. When exporting these products (technologies), the necessary procedures are to be taken in accordance with related laws and regulations.

-
- For inquiries relating to the products, please contact nearest overseas representatives that is located "Inquiry" portion on the top page of a home page.
-

Hitachi power semiconductor home page address <http://www.hitachi-power-semiconductor-device.co.jp/en/>