

MDM800E33D

FEATURES

- * Low noise due to soft and fast recovery diodes.
- * High reliability, high durability diodes.
- * Isolated heat sink (terminal to base).

ABSOLUTE MAXIMUM RATINGS (TC=25°C)

Item	Symbol	Unit	MDM800E33D
Repetitive Peak Reverse Voltage	V_{RRM}	V	3,300
Forward Current	DC	I_F	800
	1ms	I_{FM}	1,600
Junction Temperature	T_J	°C	-40 ~ +125
Storage Temperature	T_{stg}	°C	-40 ~ +125
Isolation Test Voltage	V_{ISO}	V_{RMS}	6,000(AC 1 minute)
Screw Torque	Terminals (M8)	-	15 (1)
	Mounting (M6)	-	6 (2)

Notes: (1) Recommended Value $15^{+0.3}_{-0.3}$ N·m (2) Recommended Value 5.5 ± 0.5 N·m

ELECTRICAL CHARACTERISTICS

Item	Symbol	Unit	Min.	Typ.	Max.	Test Conditions
Repetitive Reverse Current	I_{RRM}	mA	-	2.0	20.0	$V_{AK}=3,300V, T_J=125^\circ C$
Forward Voltage Drop	V_F	V	2.0	2.5	3.0	$I_F=800A, T_J=125^\circ C$ at chip level
Reverse Recovery Time	t_{rr}	μs	0.2	0.6	1.1	$V_{CC}=1,650V, I_F=800A, L=120nH$
Reverse Recovery Loss	$E_{rr(10\%)}$	J/P	-	0.9	1.3	$T_J=125^\circ C, R_g=4.7\Omega$ (3)

Notes:(3) Counter arm: MBN800E33D $V_{GE}=\pm 15V$

R_G value is the test condition's value to define the switching characteristics not recommended value.

Please, determine the suitable R_G value after the measurement of switching waveforms (overshoot voltage, etc.) with appliance mounted.

PACKAGE CHARACTERISTICS

Item	Symbol	Unit	Min.	Typ.	Max.	Test Conditions
Terminal Resistance	RCE	m Ω	-	0.4	-	
Terminal Stray Inductance	L_{sCE}	nH	-	35	-	
Thermal Impedance	$R_{th(j-c)}$	K/W	-	-	0.026	Junction to case
Comparative tracking index	CTI	-	-	600	-	
Contact Thermal Impedance	$R_{th(c-f)}$	K/W	-	0.008	-	Case to fin per module

* Please contact our representatives at order.

* For improvement, specifications are subject to change without notice.

* For actual application, please confirm this spec sheet is the newest revision.

MDM800E33D

DEFINITION OF TEST CIRCUIT

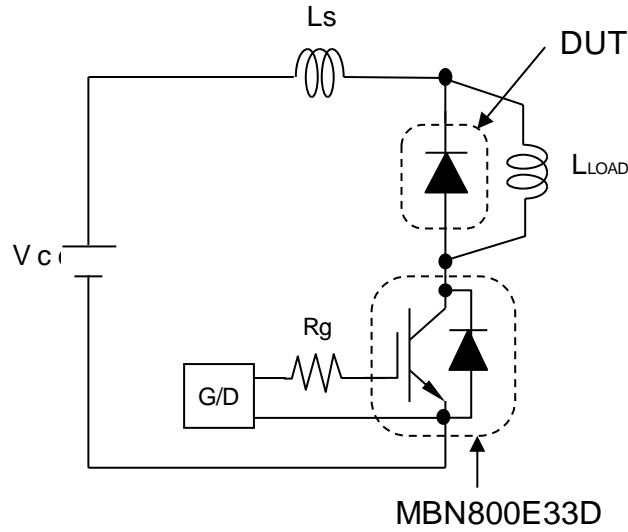

Fig.1 Switching test circuit

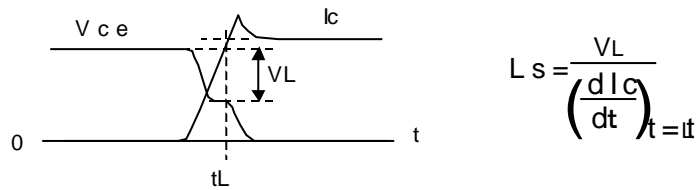
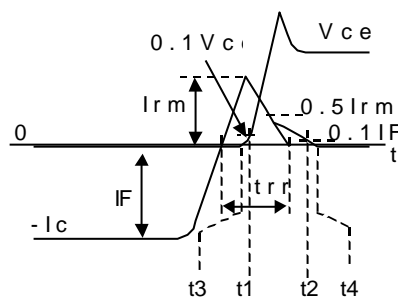

Fig.2 Definition of stray inductance



$$Err(10\%) = \int_{t1}^{t2} IF \cdot Vce \, dt$$

$$Err(Full) = \int_{t3}^{t4} IF \cdot Vce \, dt$$

Fig.3 Definition of switching loss

MDM800E33D

CHARACTERISTICS CURVE

STATIC CHARACTERISTICS

TYPICAL

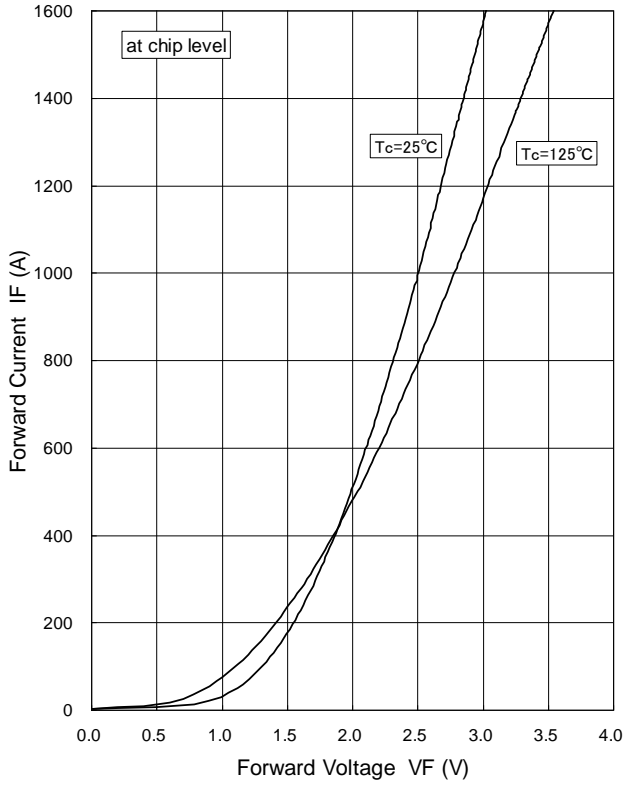

DEPENDENCE OF CURRENT

TYPICAL

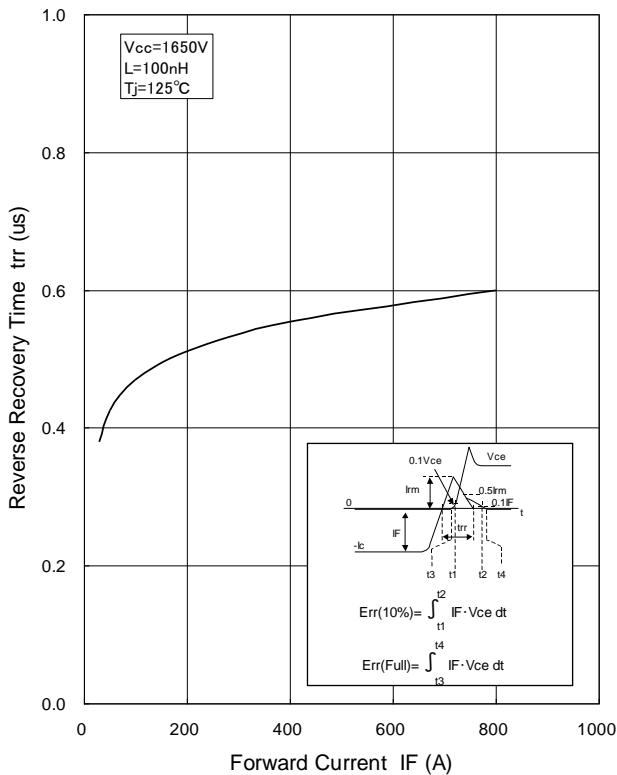

TYPICAL

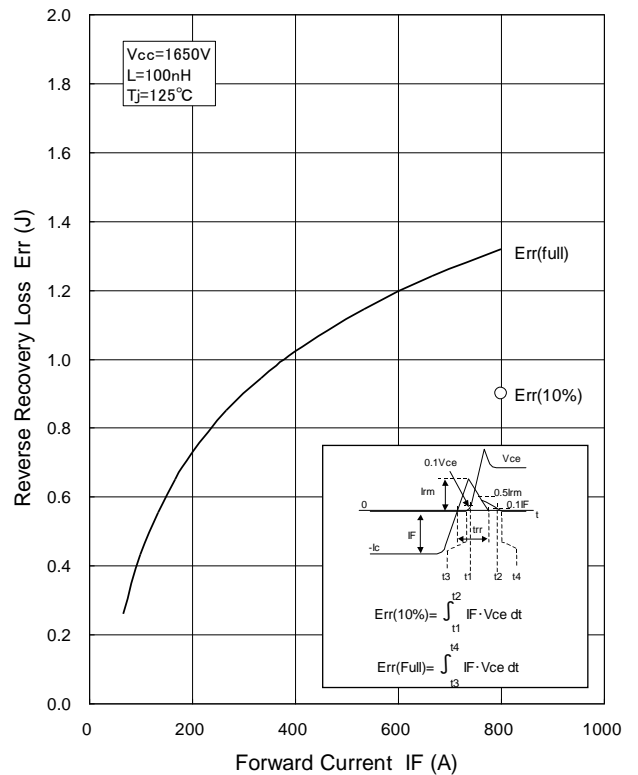

MDM800E33D

PACKAGE OUTLINE DRAWING

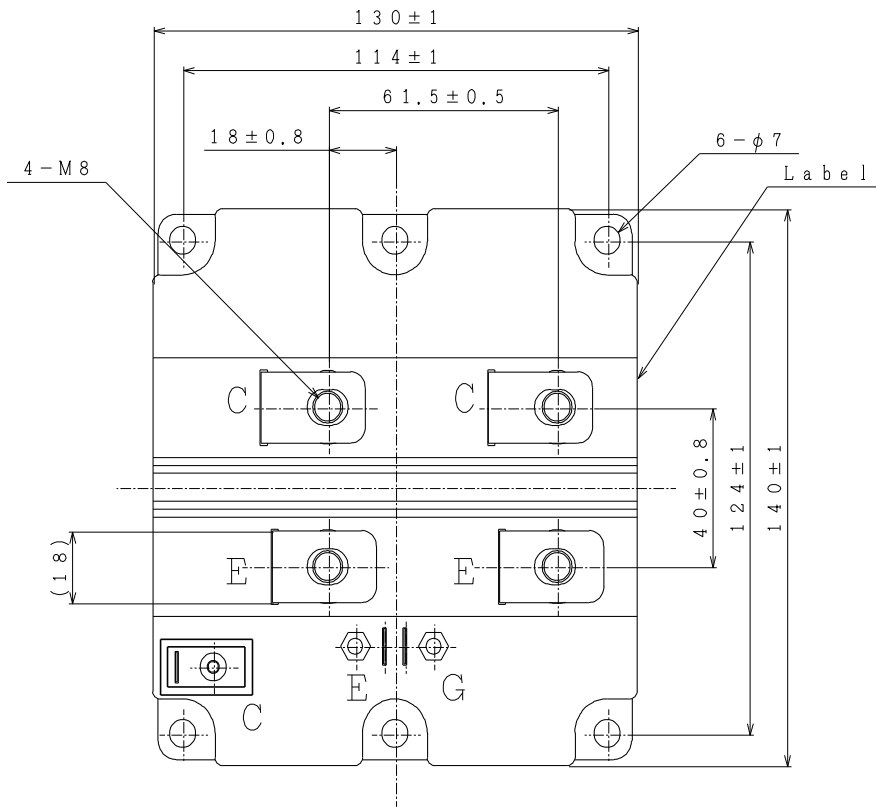

Unit in mm

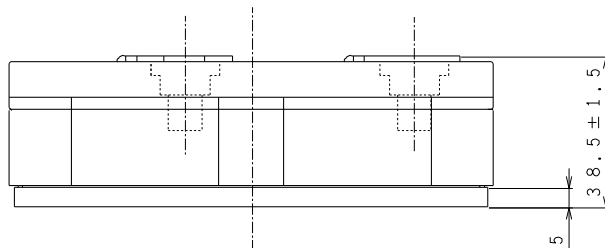
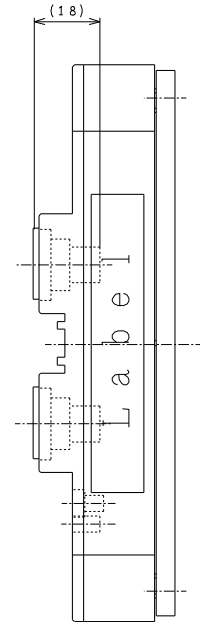

Weight: 900(g)

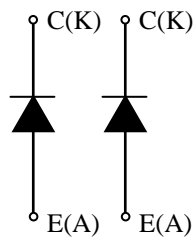

Circuit diagram

MDM800E33D

TRANSIENT THERMAL IMPEDANCE

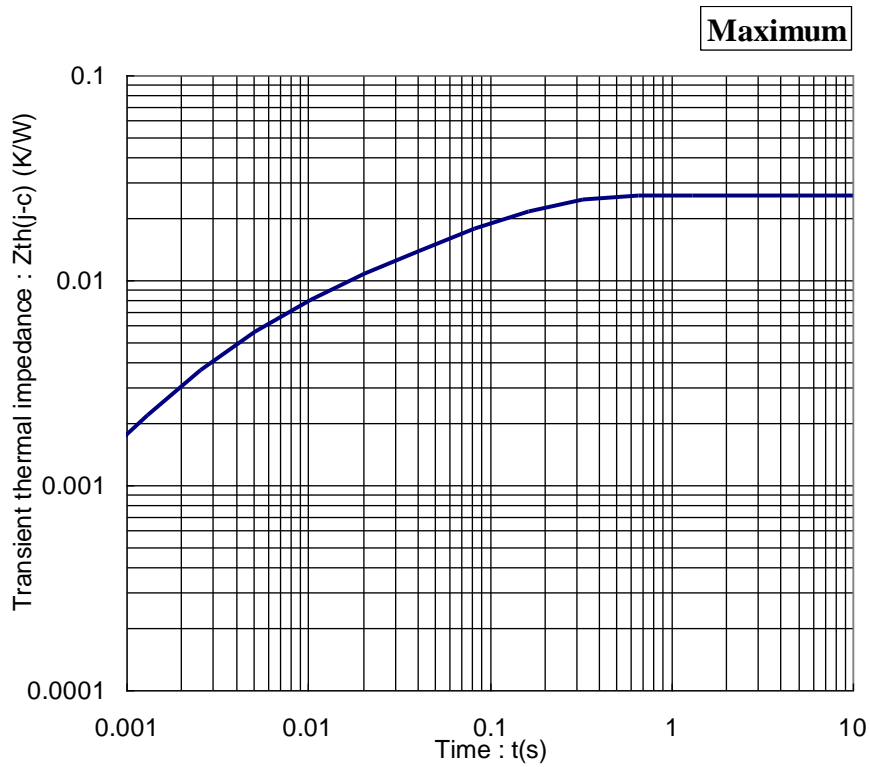

Transient Thermal Impedance Curve

Material declaration

Please note the following materials are contained in the product, in order to keep characteristic and reliability level.

Material	Contained part
Lead (Pb) and its compounds	Solder

MDM800E33D

HITACHI POWER SEMICONDUCTORS

Notices

1. The information given herein, including the specifications and dimensions, is subject to change without prior notice to improve product characteristics. Before ordering, purchasers are advised to contact Hitachi sales department for the latest version of this data sheets.
2. Please be sure to read "Precautions for Safe Use and Notices" in the individual brochure before use.
3. In cases where extremely high reliability is required (such as use in nuclear power control, aerospace and aviation, traffic equipment, life-support-related medical equipment, fuel control equipment and various kinds of safety equipment), safety should be ensured by using semiconductor devices that feature assured safety or by means of users' fail-safe precautions or other arrangement. Or consult Hitachi's sales department staff.
4. In no event shall Hitachi be liable for any damages that may result from an accident or any other cause during operation of the user's units according to this data sheets. Hitachi assumes no responsibility for any intellectual property claims or any other problems that may result from applications of information, products or circuits described in this data sheets.
5. In no event shall Hitachi be liable for any failure in a semiconductor device or any secondary damage resulting from use at a value exceeding the absolute maximum rating.
6. No license is granted by this data sheets under any patents or other rights of any third party or Hitachi Power Semiconductor Device, Ltd.
7. This data sheets may not be reproduced or duplicated, in any form, in whole or in part, without the expressed written permission of Hitachi Power Semiconductor Device, Ltd.
8. The products (technologies) described in this data sheets are not to be provided to any party whose purpose in their application will hinder maintenance of international peace and safety not are they to be applied to that purpose by their direct purchasers or any third party. When exporting these products (technologies), the necessary procedures are to be taken in accordance with related laws and regulations.

-
- For inquiries relating to the products, please contact nearest overseas representatives that is located "Inquiry" portion on the top page of a home page.
-

Hitachi power semiconductor home page address <http://www.hitachi-power-semiconductor-device.co.jp/en/>