

MBB600TV6A

Silicon N-channel IGBT

1. FEATURES

- * High speed, low loss IGBT module.
- * Low thermal impedance due to direct liquid cooling.
- * High reliability, high durability module.

2. ABSOLUTE MAXIMUM RATINGS (T_c=25°C)

Item	Symbol	Unit	Specification
Collector Emitter Voltage	V _{CES}	V	650
Gate Emitter Voltage	V _{GES}	V	±20
Collector Current	DC	I _c	600
	1ms	I _{cp}	1200
Forward Current	DC	I _F	600
	1ms	I _{FM}	1200
Maximum Junction Temperature	T _{jmax}	°C	175
Temperature under switching conditions	T _{jop}	°C	-40 ~ +150
Storage Temperature	T _{stg}	°C	-40 ~ +125
Isolation Voltage	V _{ISO}	V _{RMS}	2,500 (AC 1 minute)
Screw Torque	Terminals (M6)	-	6.0 (1)
	Mounting (M5)	-	4.0 (2)

Notes: Recommended Value (1)5.5±0.5N·m (2)3.5±0.5N·m

3. ELECTRICAL CHARACTERISTICS

Item	Symbol	Unit	Min.	Typ.	Max.	Test Conditions	
Collector Emitter Cut-Off Current	I _{CES}	mA	-	-	1.0	V _{ce} =650V, V _{ge} =0V, T _j =25°C	
Gate Emitter Leakage Current	I _{GES}	nA	-	-	±500	V _{ge} =±20V, V _{ce} =0V, T _j =25°C	
Collector Emitter Saturation Voltage	V _{CE(sat)}	V	1.3	1.65	2.1	I _c =600A, V _{ge} =15V, T _j =25°C	
			-	1.9	-	I _c =600A, V _{ge} =15V, T _j =150°C	
Gate Emitter Threshold Voltage	V _{GE(TO)}	V	6.0	6.7	7.5	V _{ce} =5V, I _c =600mA, T _j =25°C	
Input Capacitance	C _{ies}	nF	-	53	-	V _{ce} =10V, V _{ge} =0V, f=100kHz, T _j =25°C	
Switching Times	Rise Time	t _r	-	0.15	0.4	V _{cc} =300V, I _c =600A	
	Turn On Time	t _{on}	-	0.50	0.9	L _s =30nH, R _{g(ext)} =4.7Ω, C _{ge} =56nF	
	Fall Time	t _f	-	0.35	0.8	V _{ge} =+15V/0V, T _j =150°C	
	Turn Off Time	t _{off}	-	1.20	2.0	Inductive load	
Peak Forward Voltage Drop	V _F	V	1.1	1.45	1.8	I _f =600A, V _{GE} =0V, T _j =25°C	
			-	1.5	-	I _f =600A, V _{GE} =0V, T _j =150°C	
Reverse Recovery Time	t _{rr}	μs	-	0.35	0.8	V _{cc} =300V, I _c =600A,	
Turn On Loss	E _{on(full)}	mJ/P	-	20	30	L _s =30nH, R _{g(ext)} =4.7Ω, C _{ge} =56nF	
Turn Off Loss	E _{off(full)}	mJ/P	-	45	65	V _{ge} =+15V/0V, T _j =150°C	
Reverse Recovery Loss	E _{rr(full)}	mJ/P	-	15	23	Inductive load	
Thermistor Resistance	R	kΩ	-	5	-	T _c =25°C	
			-	0.16	-	T _c =150°C	
Leakage Current between Thermistor and Other Terminals		mA	-	-	0.1	V=600Vp	
Thermal Resistance	IGBT	R _{th(j-w)}	K/W	-	-	0.145	Junction to water/fin, 10l/min, 50%LLC
	FWD	R _{th(j-w)}	K/W	-	-	0.21	(per 1 arm)

* Please contact our representatives at order.

* For improvement, specifications are subject to change without notice.

* For actual application, please confirm this spec sheet is the newest revision.

MBB600TV6A

4. PACKAGE OUTLINE DRAWING

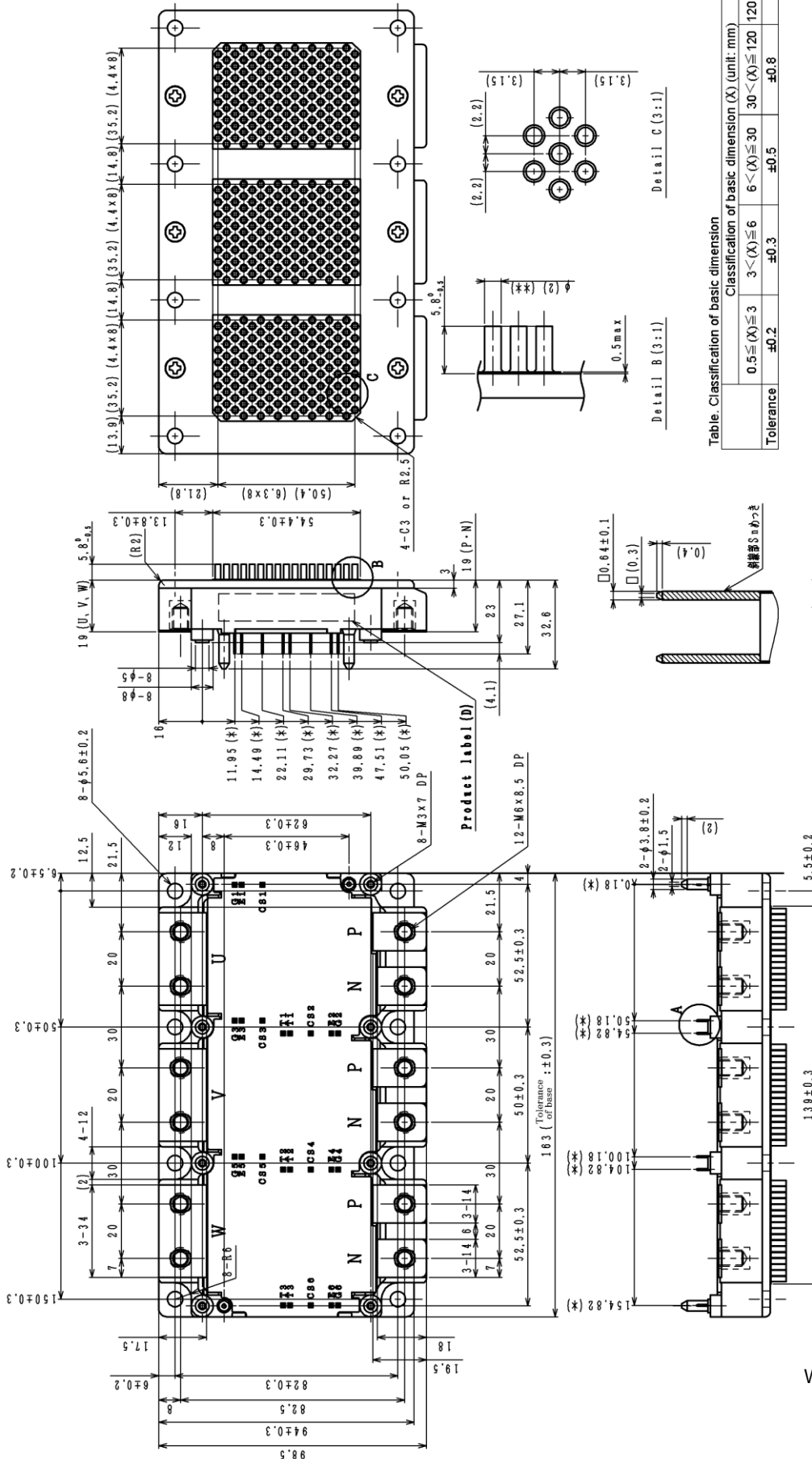

Weight : 900g

MBB600TV6A

5. CIRCUIT DIAGRAM

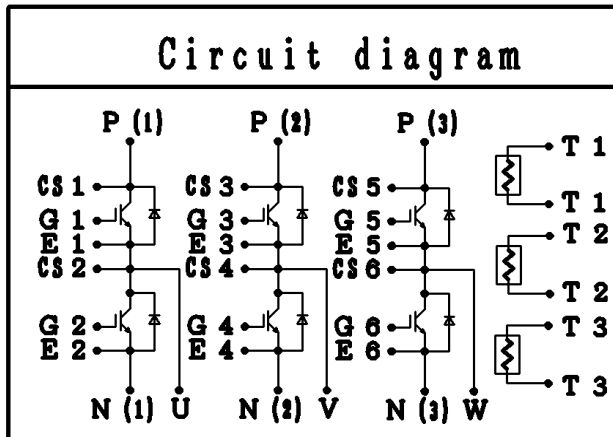

Thermistor T1, T2 and T3 are located on the same ceramic substrate with the IGBT and diode chips of phase U, V and W, respectively.

Note: This temperature measurement is not suitable for the short circuit or short term overload detection and should be used only for the module protection against long term overload or malfunction of the cooling system.

6. PRODUCT LABEL

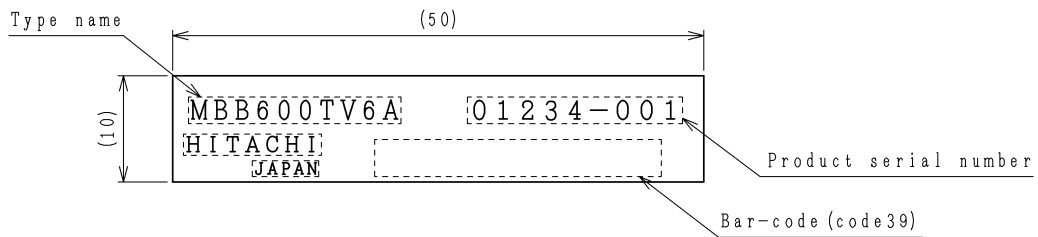

7. DEFINITION OF THE SYMBOLS

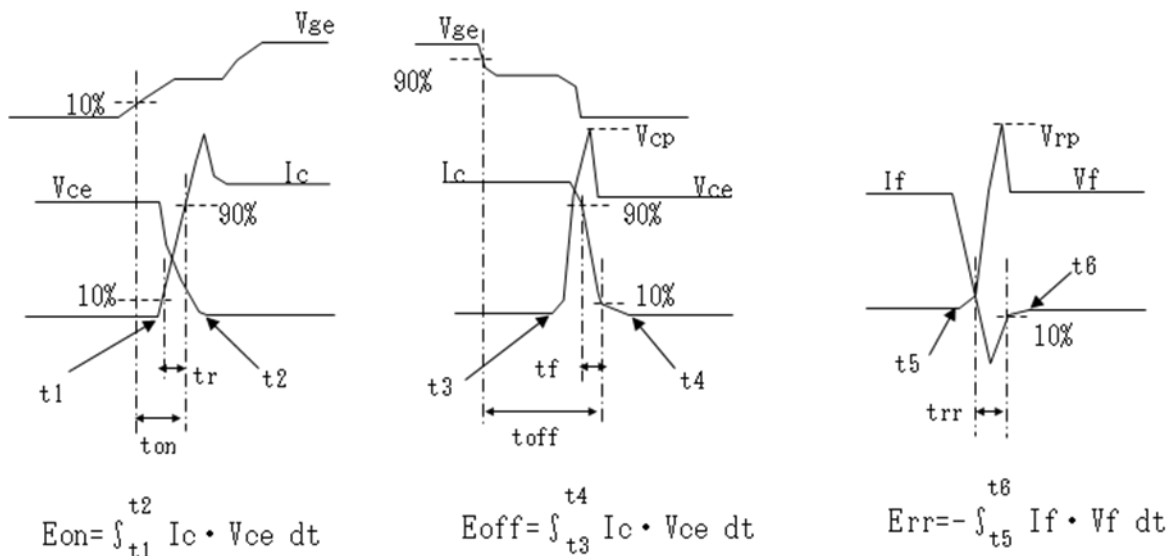

MBB600TV6A

8. STATIC CHARACTERISTICS

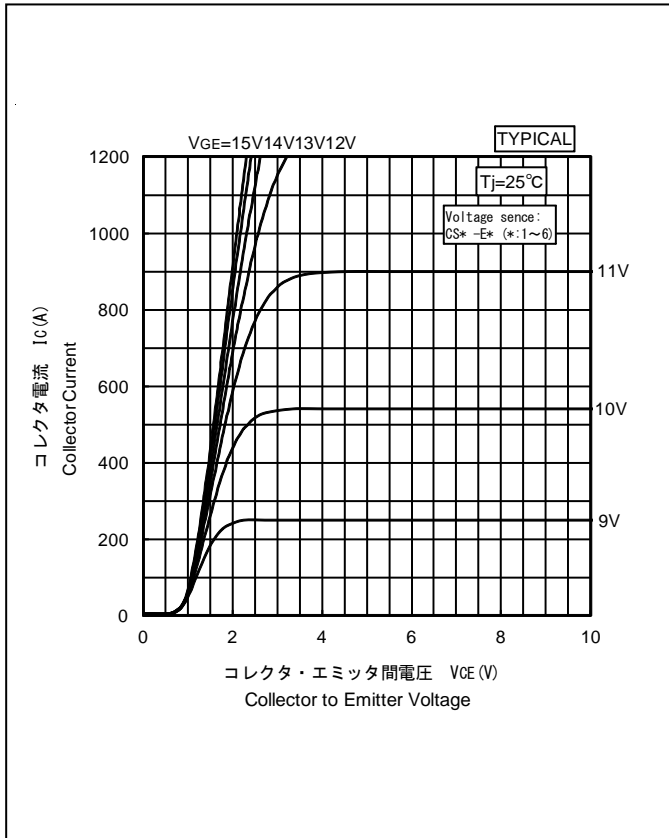

Collector Current vs. Collector to Emitter Voltage

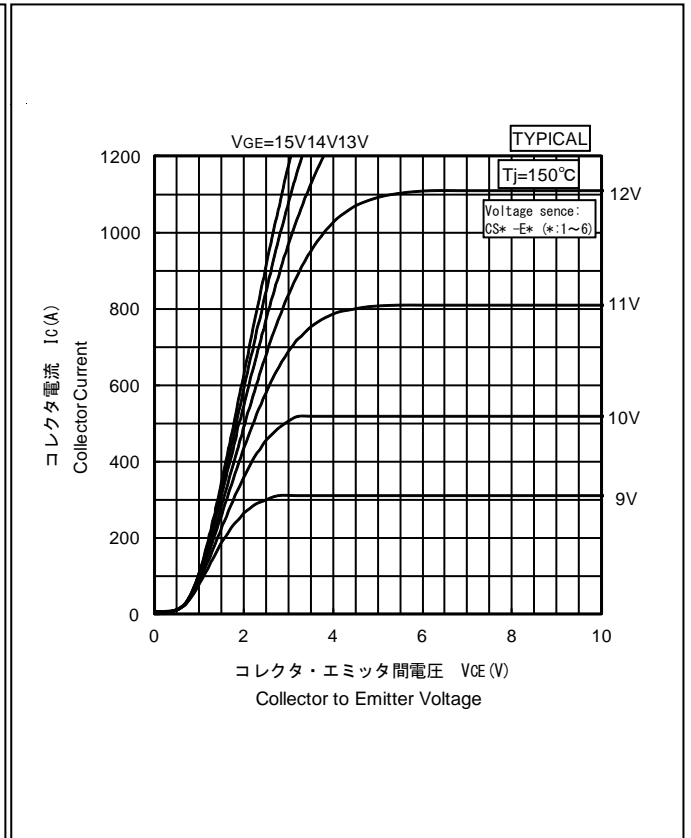

Collector Current vs. Collector to Emitter Voltage

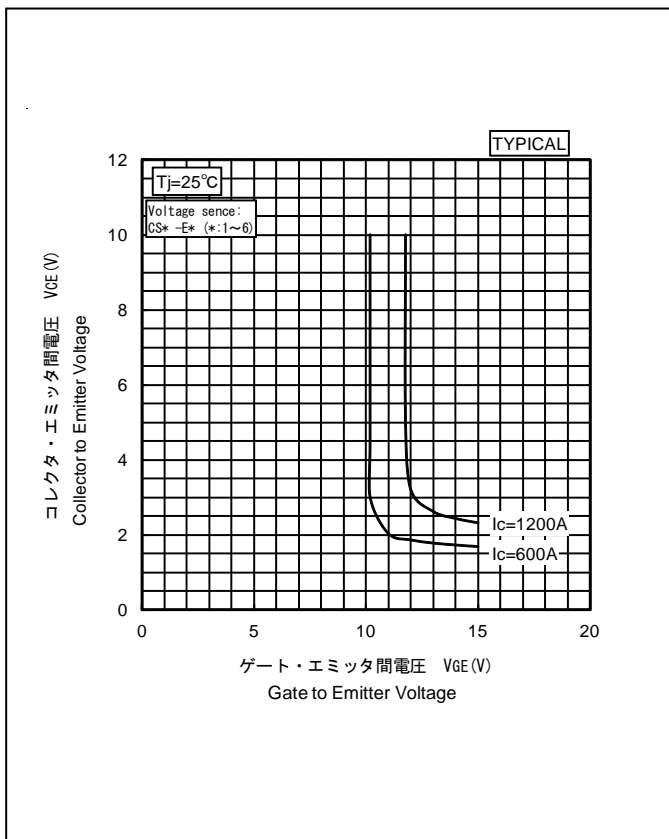

Collector to Emitter Voltage vs. Gate to Emitter Voltage

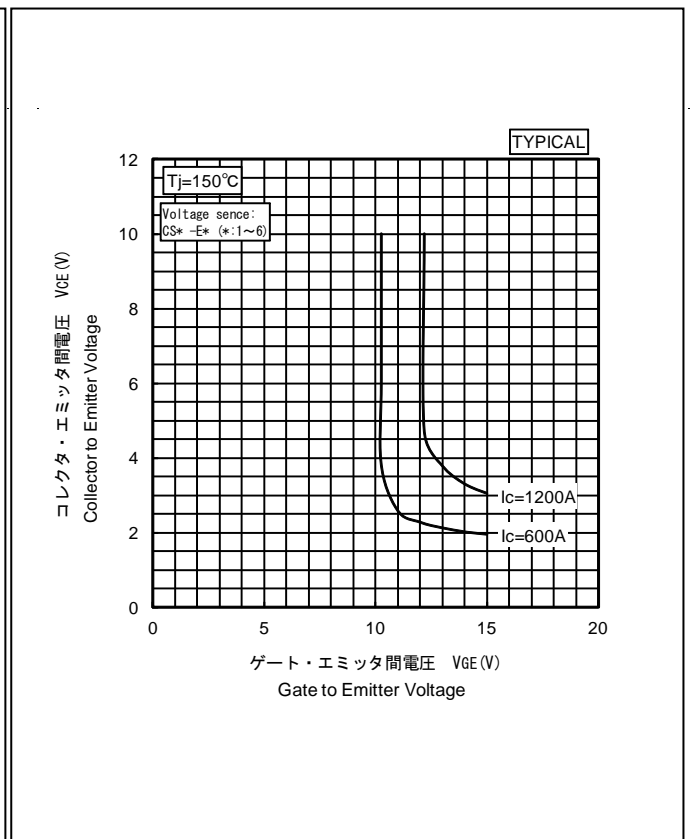

Collector to Emitter Voltage vs. Gate to Emitter Voltage

MBB600TV6A

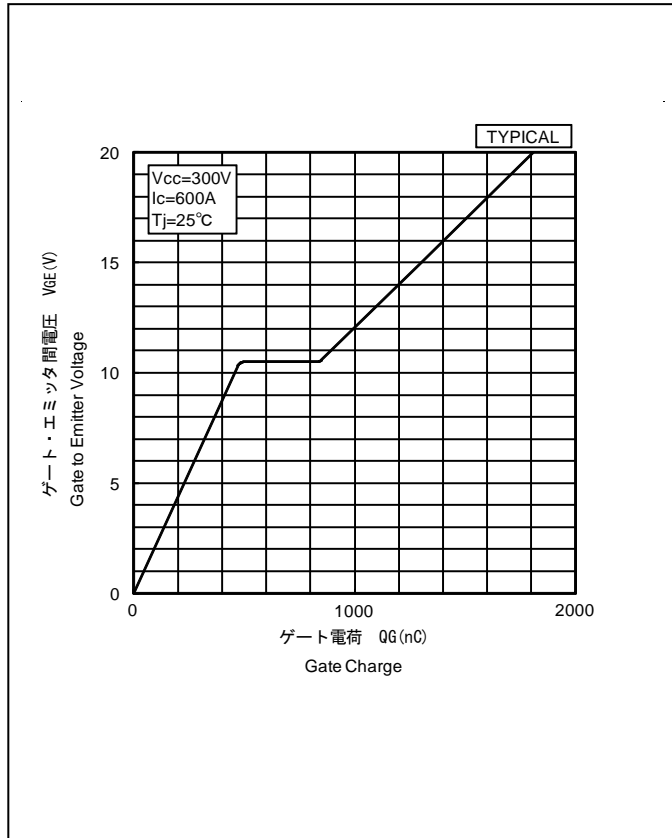

Gate Charge Characteristics

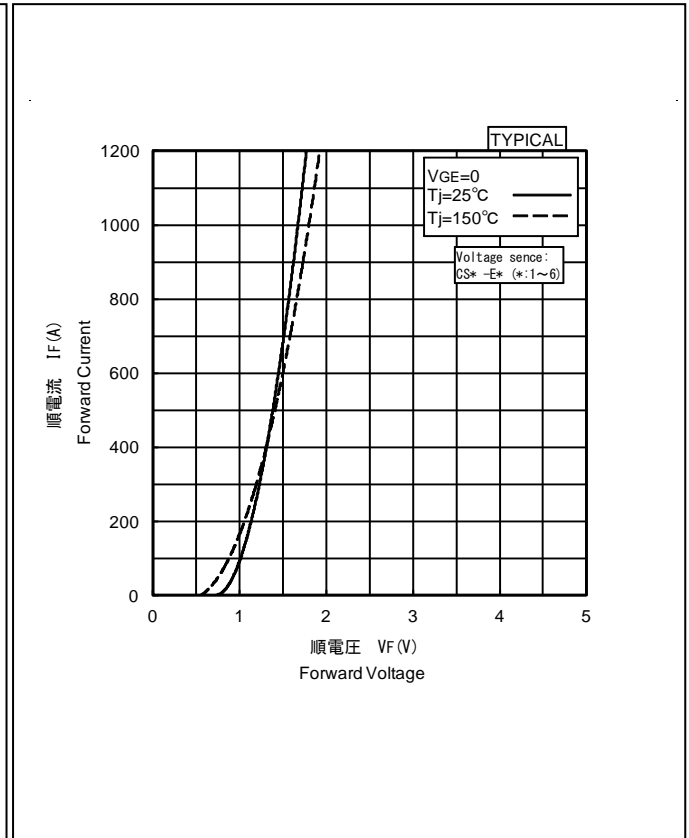

Forward Voltage of Free-Wheeling Diode

9. DYNAMIC CHARACTERISTICS

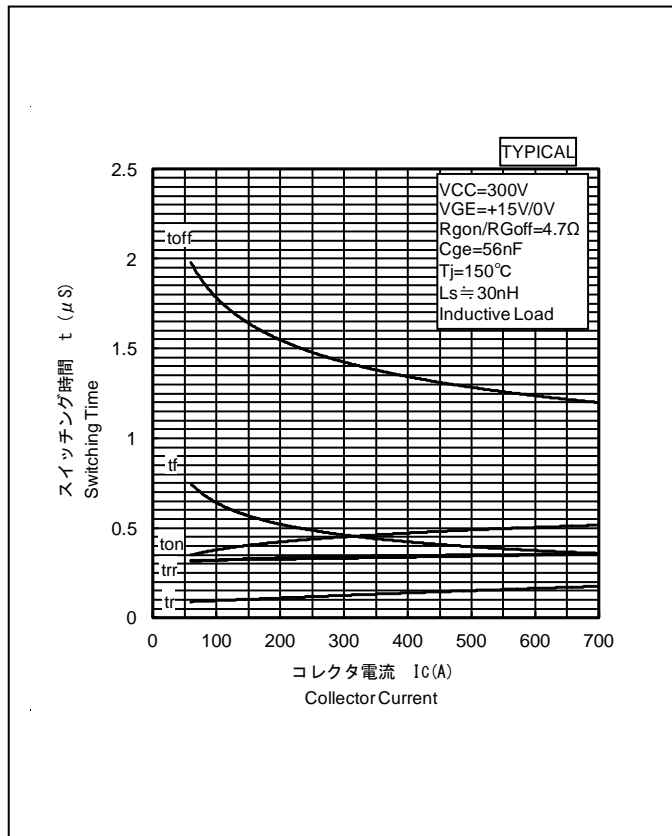

Switching Time vs. Collector Current

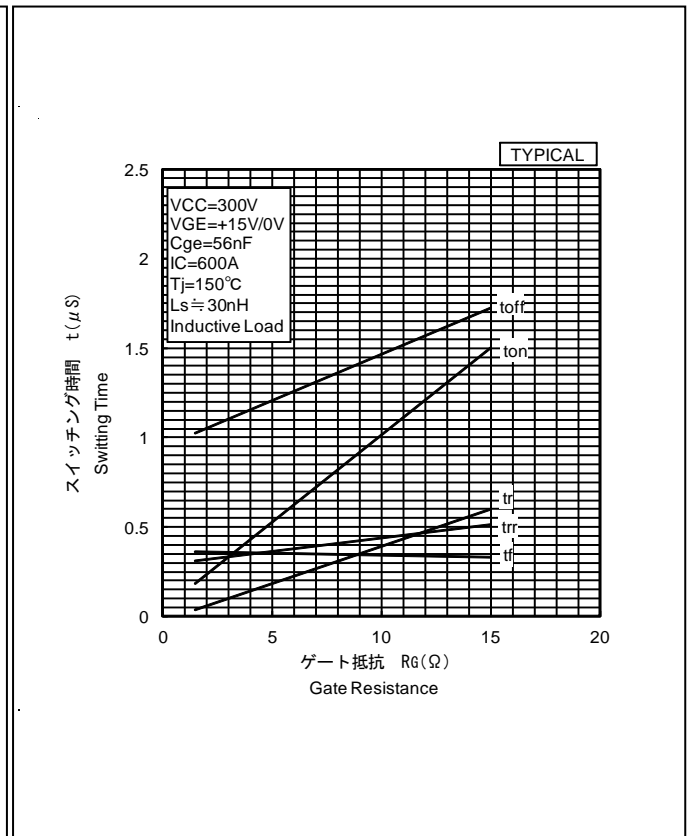

Switching Time vs. Gate Resistance

MBB600TV6A

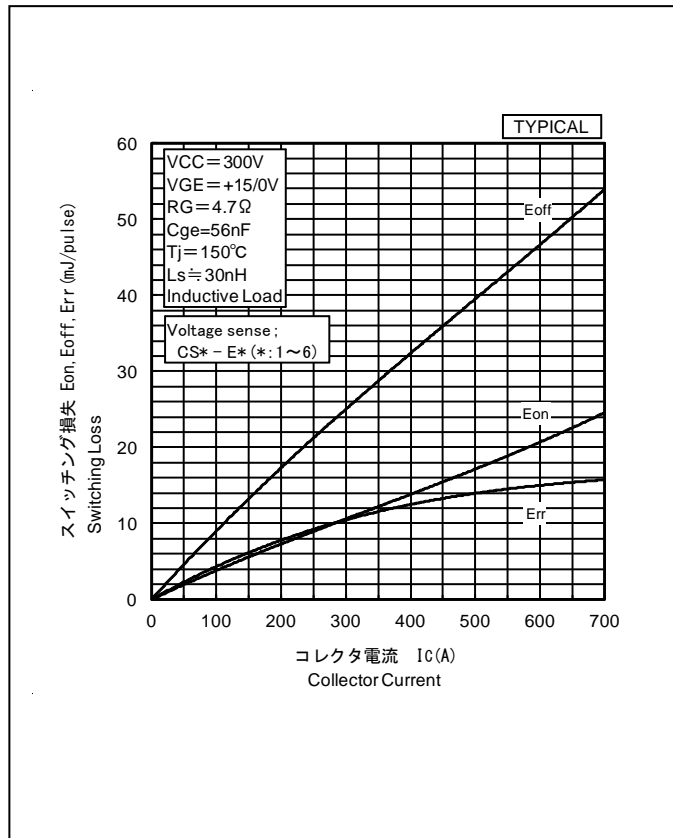

Switching Loss vs. Collector Current

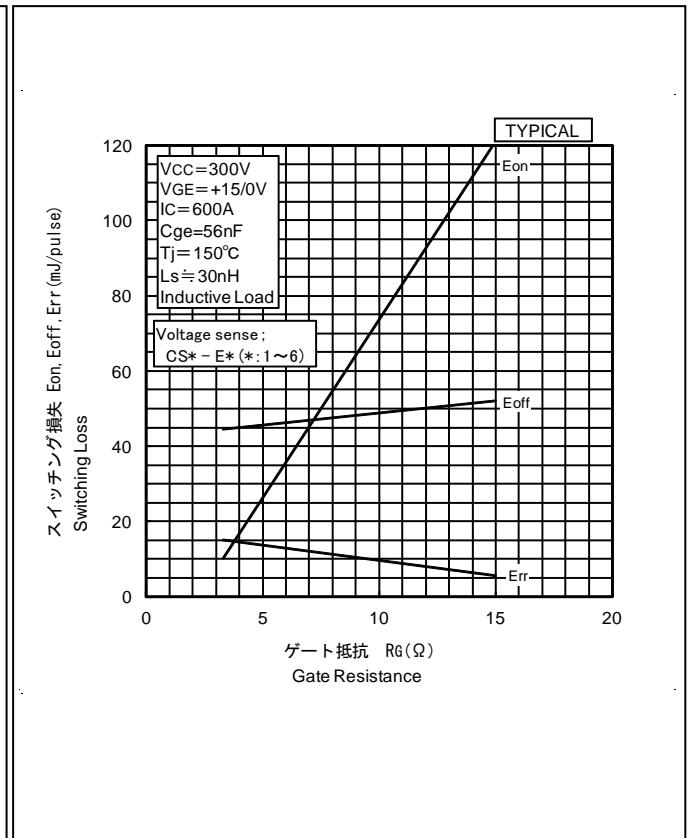

Switching Loss vs. Gate Resistance

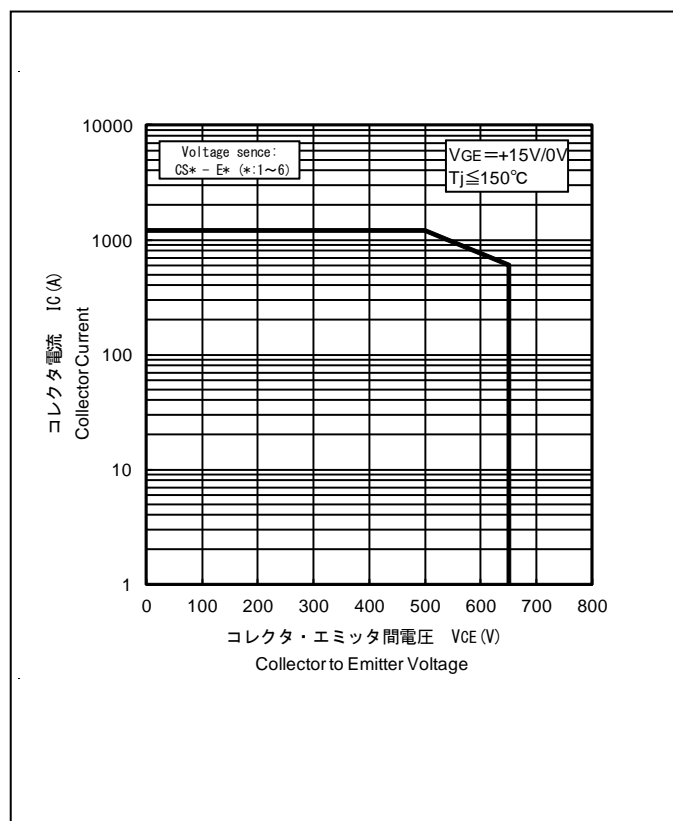

Reverse Bias Safe Operation Area (RBSOA)

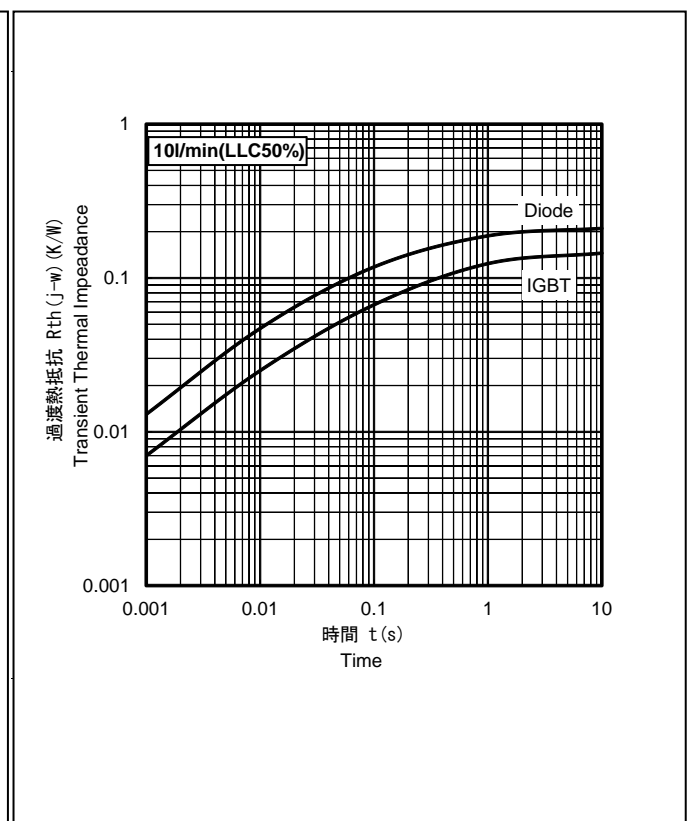

Transient Thermal Impedance Characteristics

MBB600TV6A

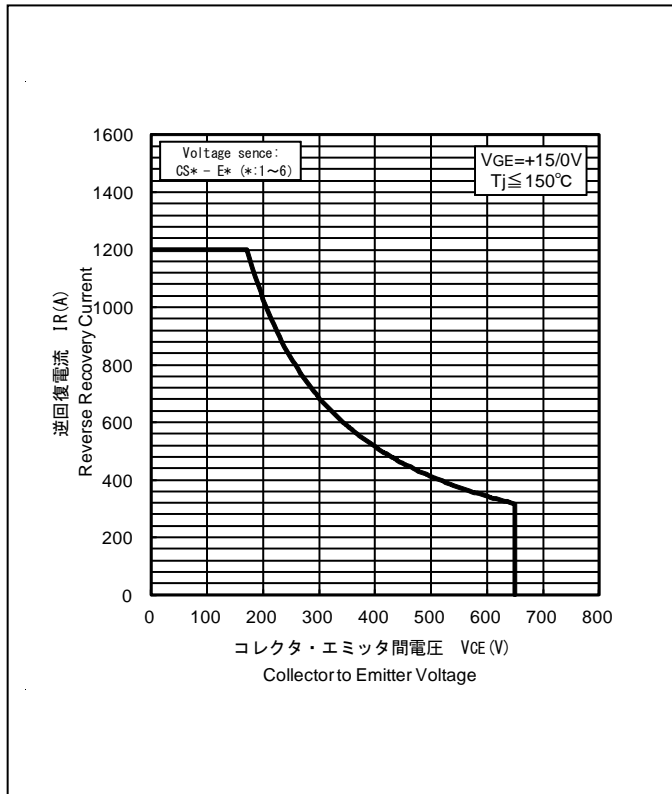

Reverse Recovery Safe Operation Area (RRSOA)

10. THERMISTOR

Table1 Specifications of Thermistor(For reference)

Nominal zero-power resistance	5kΩ ± 3% (25°C)
B value	3375K ± 2% (25~50°C)
Operating temperature range	-50~150°C
Thermal time constant (in still air)	Approx. 10 sec.

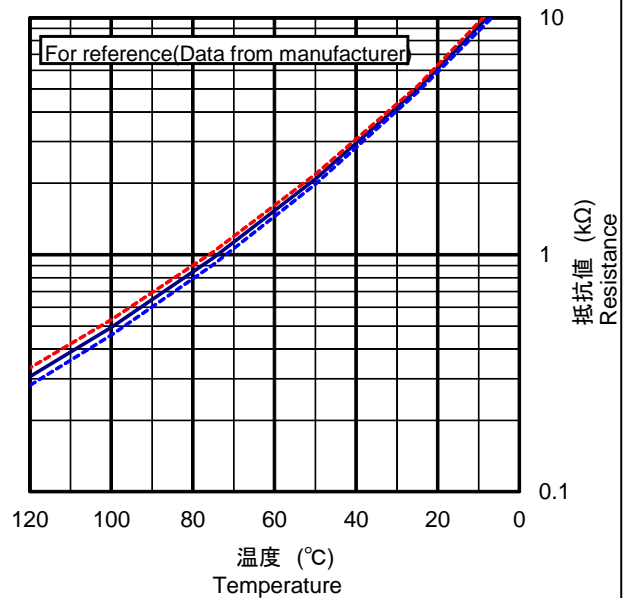

Resistance vs. Temperature

MBB600TV6A

HITACHI POWER SEMICONDUCTORS

Notices

1. The information given herein, including the specifications and dimensions, is subject to change without prior notice to improve product characteristics. Before ordering, purchasers are advised to contact Hitachi sales department for the latest version of this data sheets.
2. Please be sure to read "Precautions for Safe Use and Notices" in the individual brochure before use.
3. In cases where extremely high reliability is required (such as use in nuclear power control, aerospace and aviation, traffic equipment, life-support-related medical equipment, fuel control equipment and various kinds of safety equipment), safety should be ensured by using semiconductor devices that feature assured safety or by means of users' fail-safe precautions or other arrangement. Or consult Hitachi's sales department staff.
4. In no event shall Hitachi be liable for any damages that may result from an accident or any other cause during operation of the user's units according to this data sheets. Hitachi assumes no responsibility for any intellectual property claims or any other problems that may result from applications of information, products or circuits described in this data sheets.
5. In no event shall Hitachi be liable for any failure in a semiconductor device or any secondary damage resulting from use at a value exceeding the absolute maximum rating.
6. No license is granted by this data sheets under any patents or other rights of any third party or Hitachi Power Semiconductor Device, Ltd.
7. This data sheets may not be reproduced or duplicated, in any form, in whole or in part, without the expressed written permission of Hitachi Power Semiconductor Device, Ltd.
8. The products (technologies) described in this data sheets are not to be provided to any party whose purpose in their application will hinder maintenance of international peace and safety not are they to be applied to that purpose by their direct purchasers or any third party. When exporting these products (technologies), the necessary procedures are to be taken in accordance with related laws and regulations.

-
- For inquiries relating to the products, please contact nearest overseas representatives that is located "Inquiry" portion on the top page of a home page.
-

Hitachi power semiconductor home page address <http://www.hitachi-power-semiconductor-device.co.jp/en/>